

FYJ 1.1/2 TF SKF

Ball bearing units

TYPE: Housing units, Four-bolt flanged housing units, Cast iron housing, Radial insert ball bearing with grub screws in inner ring, Type FY/FYJ/FYM..TF (SKF), inch

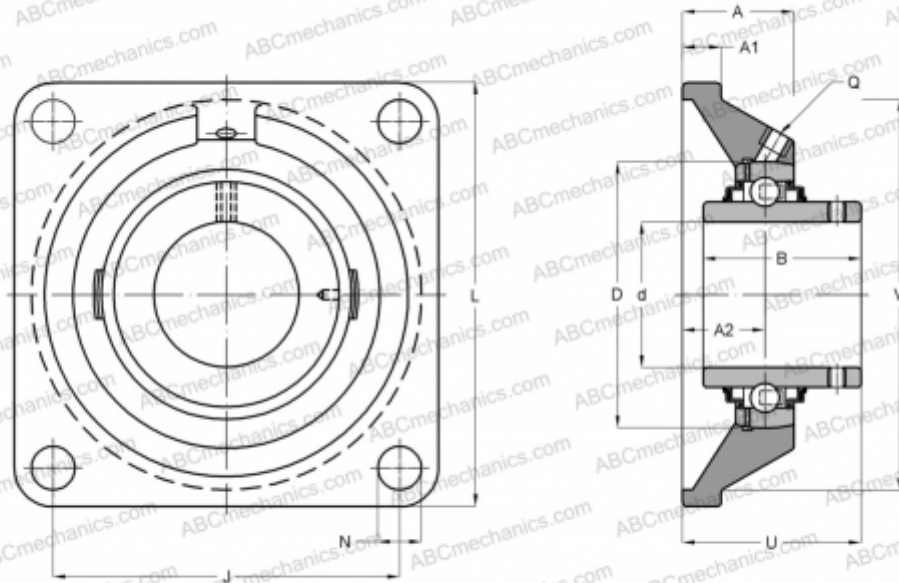

Technical specification

DIMENSIONS, MM

d	38,100
D	80,000
B	49,200
L	130,000
A	36,000
J	102,000
A1	16,000
A2	21,000
U	51,200

WEIGHT, KG 1,950

Bearing	YAR 208-108-
Housing	FYJ 508

MANUFACTURER

[SKF](#)

CALCULATION DATA

Basic dynamic load rating, C	30,700 kN
Basic static load rating, Co	19,000 kN
Fatigue load limit, Pu	0,800 kN
Limiting speed	4800 r/min