

FY 2.7/16 TF SKF

Ball bearing units

TYPE: Housing units, Four-bolt flanged housing units, Cast iron housing, Radial insert ball bearing with grub screws in inner ring, Type FY/FYJ/FYM..TF (SKF), inch

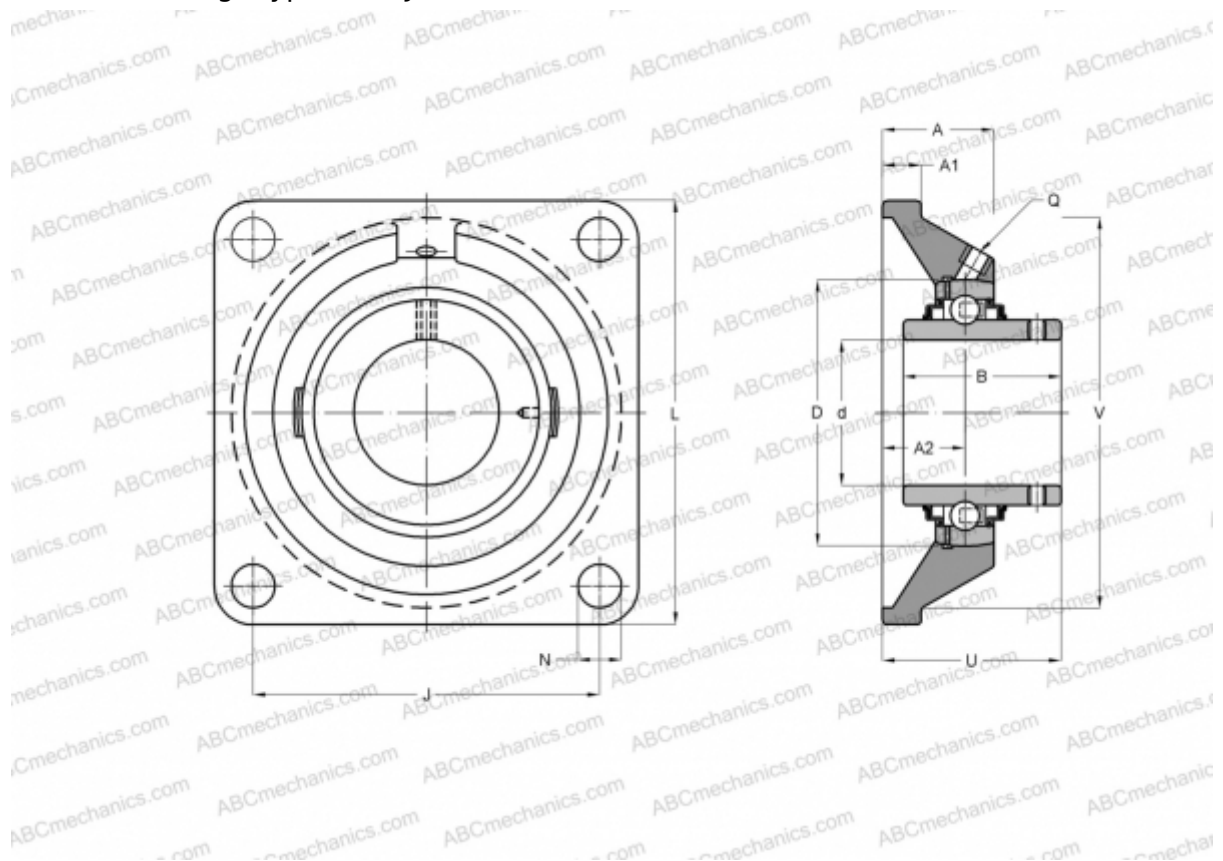

Technical specification

DIMENSIONS, MM

d	61,913
D	110,000
B	65,100
L	175,000
A	52,000
J	143,000
A1	17,000
A2	34,000
U	73,700

WEIGHT, KG 4,600

Bearing	YAR 212-207-
Housing	FY 512 U

MANUFACTURER

[SKF](#)

CALCULATION DATA

Basic dynamic load rating, C	52,700 kN
Basic static load rating, Co	36,000 kN
Fatigue load limit, Pu	1,530 kN
Limiting speed	3400 r/min