

FY 35 FM SKF

Ball bearing units

TYPE: Housing units, Four-bolt flanged housing units, Cast iron housing, Radial insert ball bearing with eccentric locking collar, Type FY..FM (SKF)

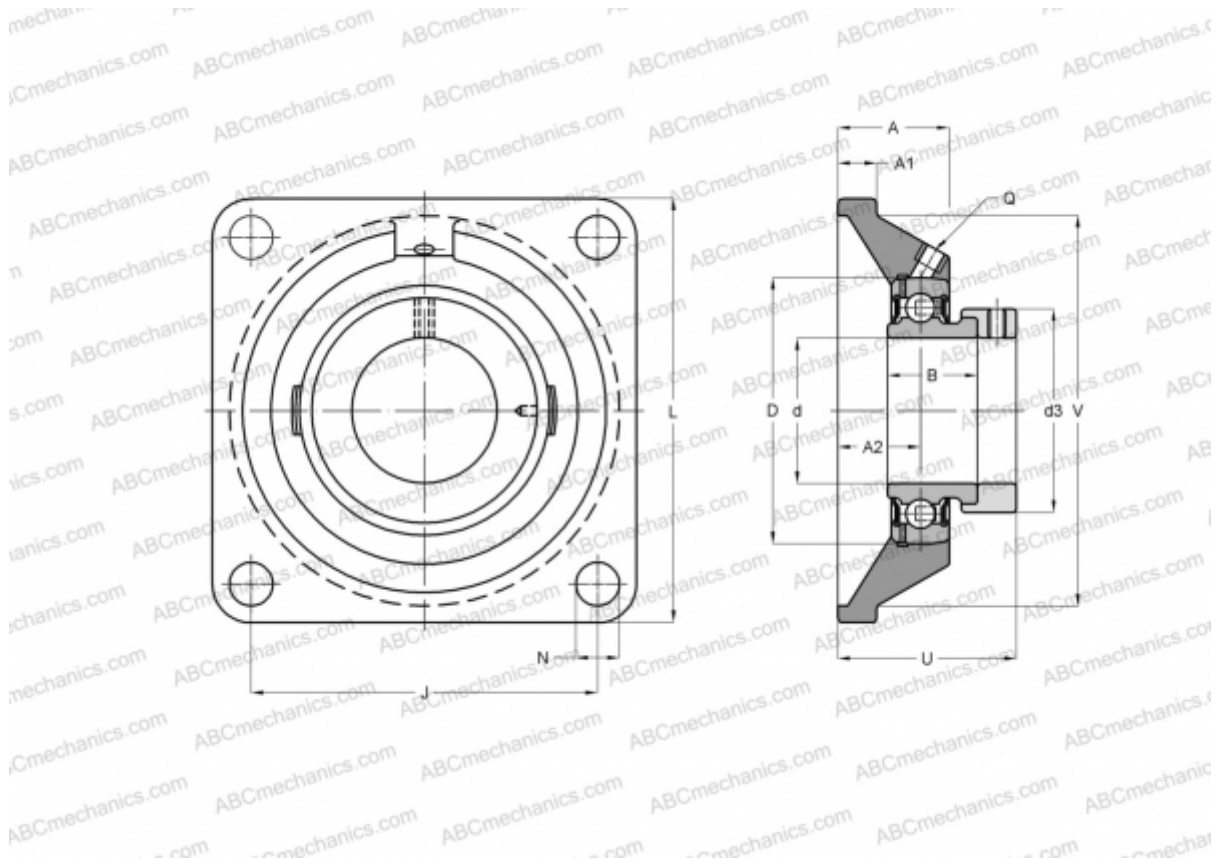

Technical specification

DIMENSIONS, MM

d	35,000
D	72,000
B	38,900
L	118,000
A	34,500
J	92,000
A1	13,000
A2	21,000
N	14,000
d3	51,100
U	50,400
V	106,400

WEIGHT, KG 1,500

Bearing	YET 207
Housing	FY 507 M
Protective cover	ECY 207

MANUFACTURER

[SKF](#)

CALCULATION DATA

Basic dynamic load rating, C	25,500 kN
Basic static load rating, Co	15,300 kN
Fatigue load limit, Pu	0,655 kN
Limiting speed	5300 r/min