

FY 40 FM SKF

Ball bearing units

TYPE: Housing units, Four-bolt flanged housing units, Cast iron housing, Radial insert ball bearing with eccentric locking collar, Type FY..FM (SKF)

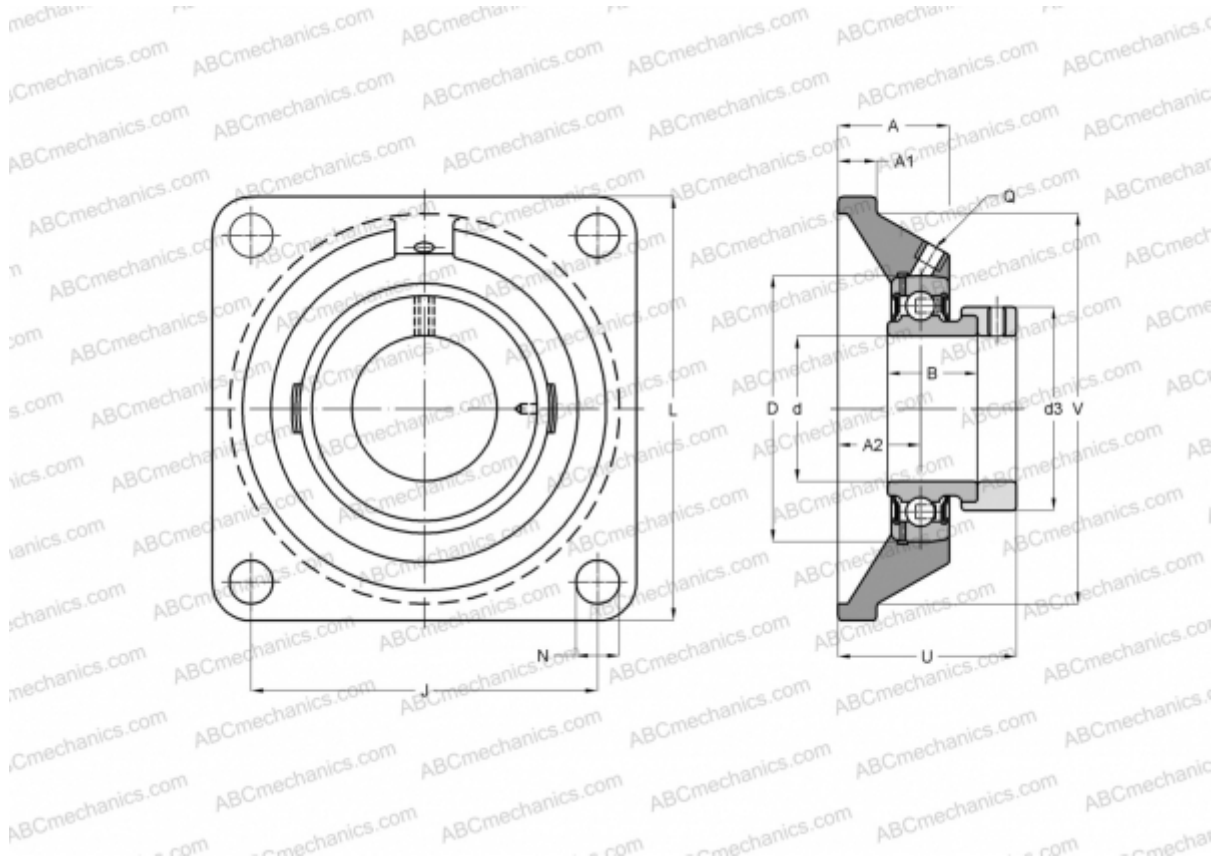

Technical specification

DIMENSIONS, MM

d	40,000
D	80,000
B	43,700
L	130,000
A	38,500
J	101,500
A1	14,000
A2	24,000
N	14,000
d3	56,500
U	56,700
V	115,900

WEIGHT, KG 1,950

Bearing	YET 208
Housing	FY 508 M
Protective cover	ECY 208

MANUFACTURER

[SKF](#)

CALCULATION DATA

Basic dynamic load rating, C	30,700 kN
Basic static load rating, Co	19,000 kN
Fatigue load limit, Pu	0,800 kN
Limiting speed	4800 r/min