

FY 55 FM SKF

Ball bearing units

TYPE: Housing units, Four-bolt flanged housing units, Cast iron housing, Radial insert ball bearing with eccentric locking collar, Type FY..FM (SKF)

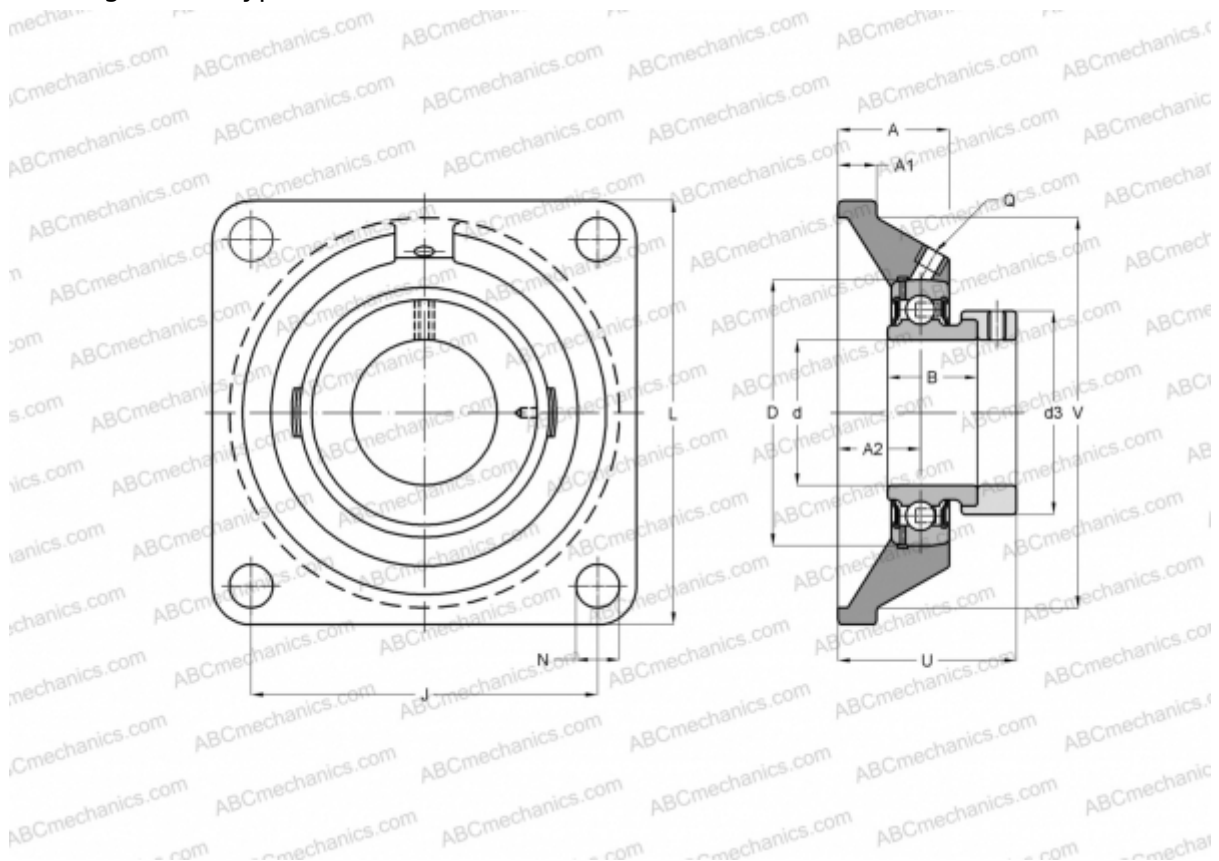

Technical specification

DIMENSIONS, MM

d	55,000
D	100,000
B	48,400
L	162,000
A	47,500
J	130,000
A1	16,000
A2	31,000
N	18,000
d3	74,500
U	67,400
V	150,800

WEIGHT, KG 3,600

Bearing	YET 211
Housing	FY 511 M
Protective cover	ECY 211

MANUFACTURER

[SKF](#)

CALCULATION DATA

Basic dynamic load rating, C	43,600 kN
Basic static load rating, Co	29,000 kN
Fatigue load limit, Pu	1,250 kN
Limiting speed	3600 r/min