

## FY 20 WF SKF

Ball bearing units

TYPE: Housing units, Four-bolt flanged housing units, Cast iron housing, Radial insert ball bearing with eccentric locking collar, Type FY..WF (SKF)

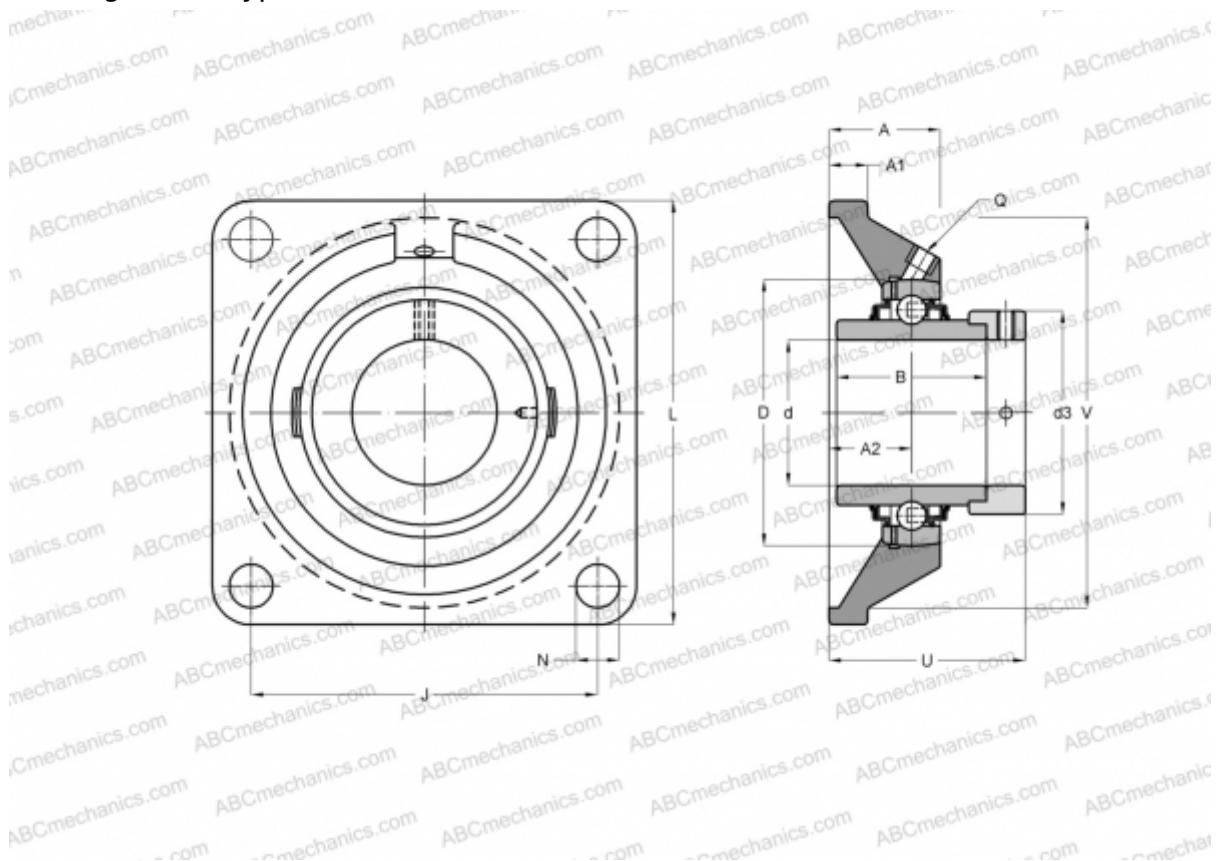

### Technical specification

#### DIMENSIONS, MM

d	20,000
D	47,000
B	43,700
L	86,000
A	29,500
J	63,500
A1	11,000
A2	19,000
N	11,500
d3	32,400
U	45,600
V	68,300

**WEIGHT, KG** 0,650

Bearing	YEL 204-2F
Housing	FY 504 M
Protective cover	ECY 204

#### MANUFACTURER

[SKF](#)

#### CALCULATION DATA

Basic dynamic load rating, C	12,700 kN
Basic static load rating, Co	6,550 kN
Fatigue load limit, Pu	0,280 kN
Limiting speed	8500 r/min