

FY 25 WF SKF

Ball bearing units

TYPE: Housing units, Four-bolt flanged housing units, Cast iron housing, Radial insert ball bearing with eccentric locking collar, Type FY..WF (SKF)

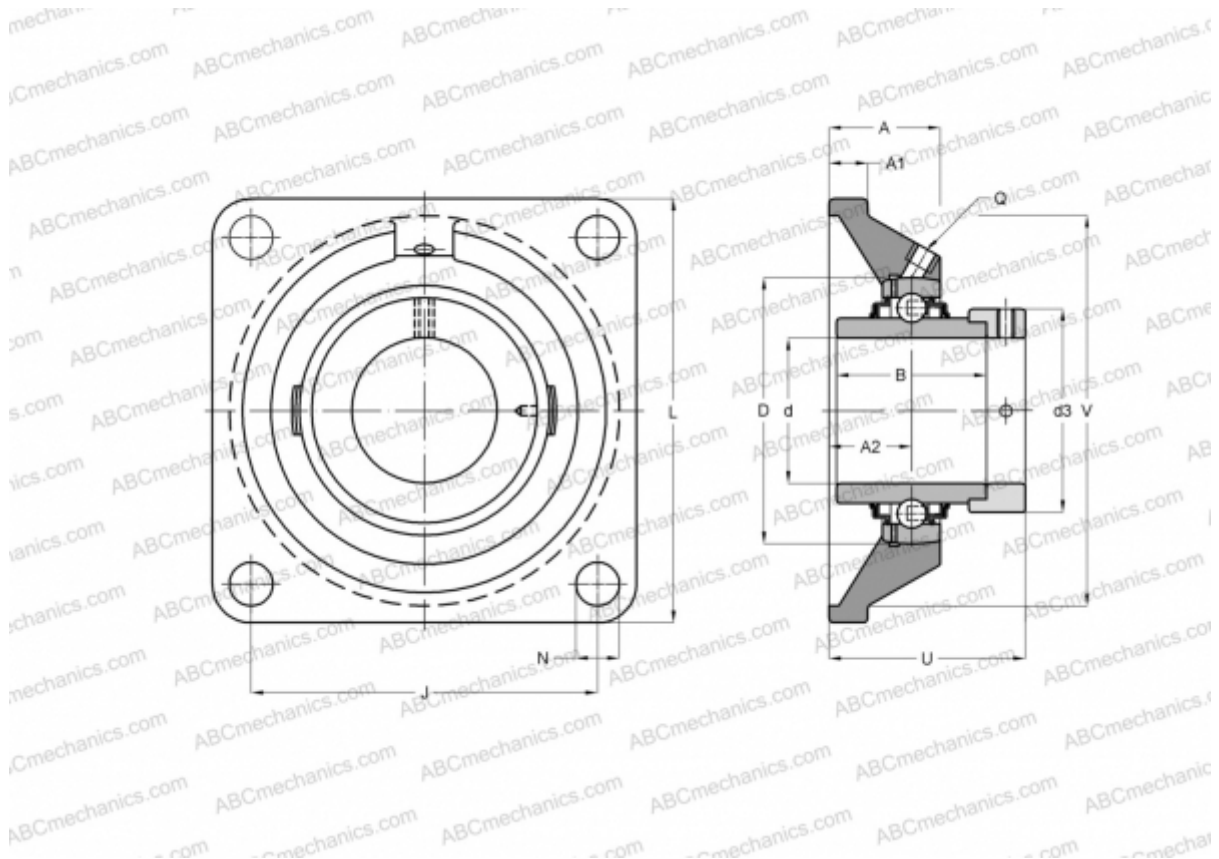

Technical specification

DIMENSIONS, MM

d	25,000
D	52,000
B	44,400
L	95,000
A	30,000
J	70,000
A1	12,000
A2	18,700
N	11,500
d3	37,400
U	45,600
V	74,600

WEIGHT, KG 0,830

Bearing	YEL 205-2F
Housing	FY 505 M
Protective cover	ECY 205

MANUFACTURER

[SKF](#)

CALCULATION DATA

Basic dynamic load rating, C	14,000 kN
Basic static load rating, Co	7,800 kN
Fatigue load limit, Pu	0,335 kN
Limiting speed	7000 r/min