

FY 45 WF SKF

Ball bearing units

TYPE: Housing units, Four-bolt flanged housing units, Cast iron housing, Radial insert ball bearing with eccentric locking collar, Type FY..WF (SKF)

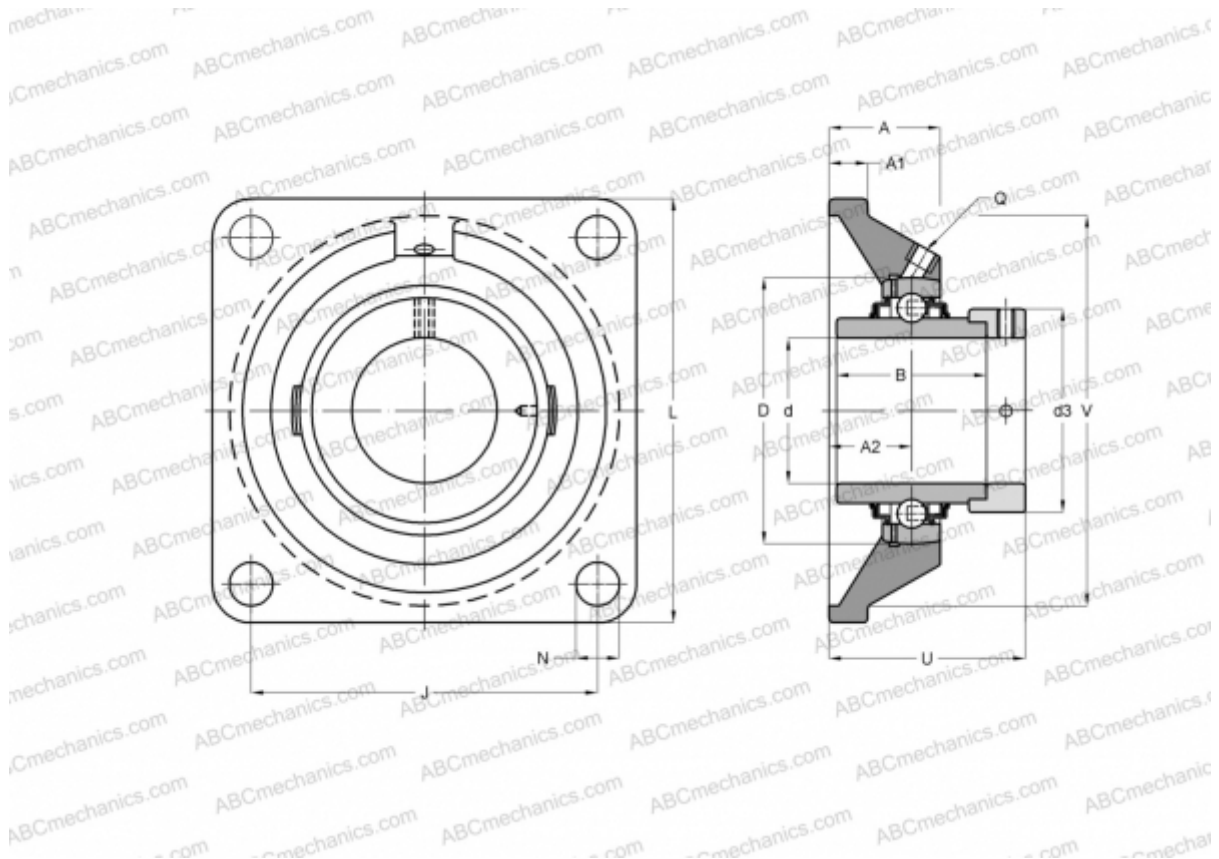

Technical specification

DIMENSIONS, MM

d	45,000
D	85,000
B	56,300
L	137,000
A	39,000
J	105,000
A1	14,000
A2	24,000
N	16,000
d3	62,000
U	58,900
V	119,100

WEIGHT, KG 2,250

Bearing	YEL 209-2F
Housing	FY 509 M
Protective cover	ECY 209

MANUFACTURER

[SKF](#)

CALCULATION DATA

Basic dynamic load rating, C	33,200 kN
Basic static load rating, Co	21,600 kN
Fatigue load limit, Pu	0,915 kN
Limiting speed	4300 r/min