

FY 50 WF SKF

Ball bearing units

TYPE: Housing units, Four-bolt flanged housing units, Cast iron housing, Radial insert ball bearing with eccentric locking collar, Type FY..WF (SKF)

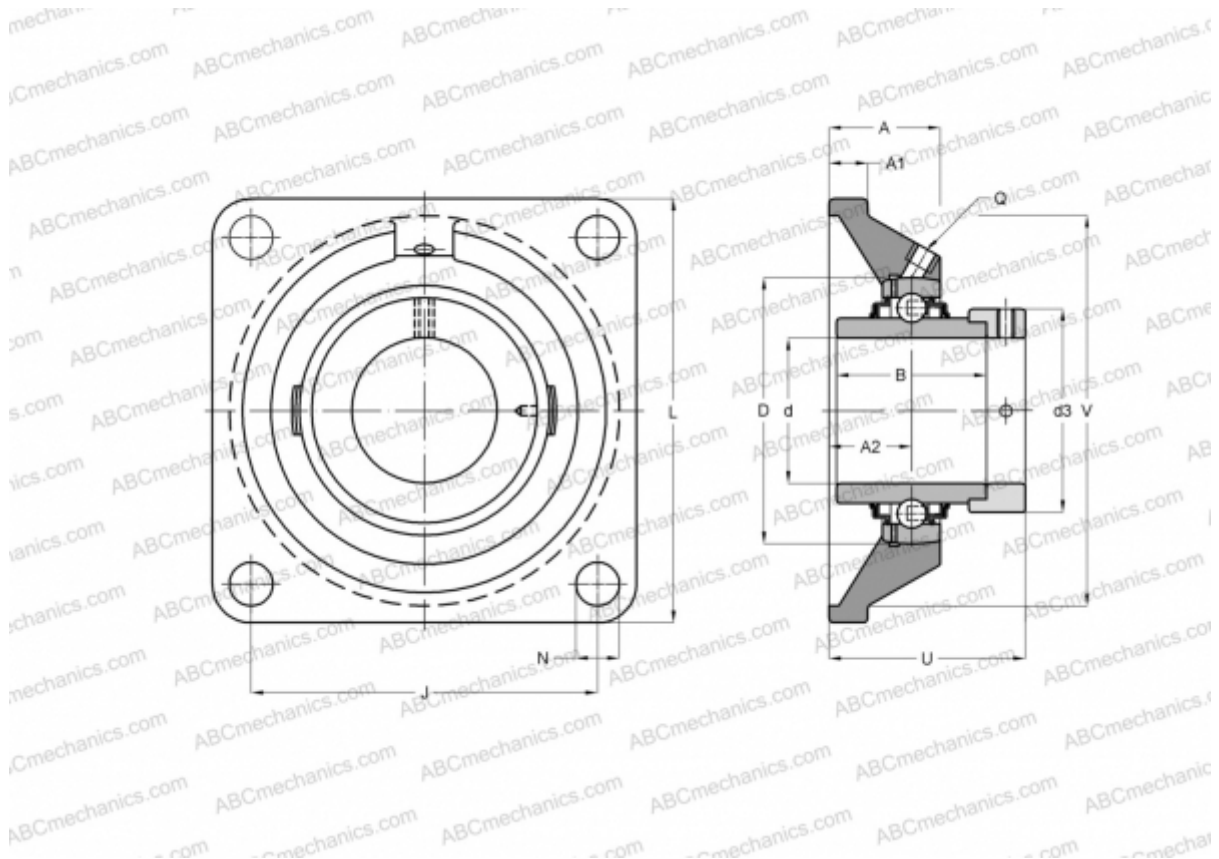

Technical specification

DIMENSIONS, MM

d	50,000
D	90,000
B	62,700
L	143,000
A	43,000
J	111,000
A1	15,000
A2	28,000
N	18,000
d3	67,200
U	66,100
V	125,400

WEIGHT, KG 2,700

Bearing	YEL 210-2F
Housing	FY 510 M
Protective cover	ECY 210

MANUFACTURER

[SKF](#)

CALCULATION DATA

Basic dynamic load rating, C	35,100 kN
Basic static load rating, Co	23,200 kN
Fatigue load limit, Pu	0,980 kN
Limiting speed	4000 r/min