

FY 5/8 FM SKF

Ball bearing units

TYPE: Housing units, Four-bolt flanged housing units, Cast iron housing, Radial insert ball bearing with eccentric locking collar, Type FY..FM (SKF), inch

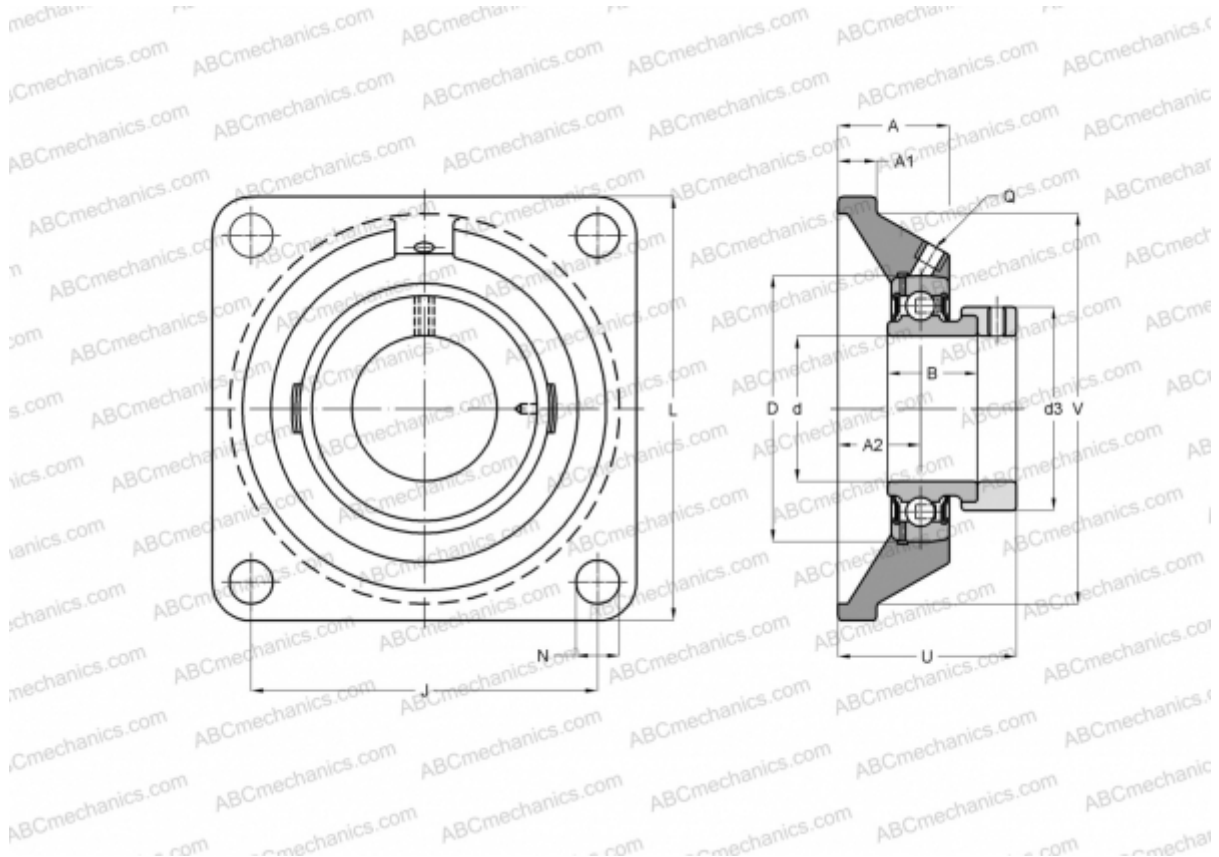

Technical specification

DIMENSIONS, MM

d	15,875
D	40,000
B	28,600
L	76,200
A	23,400
J	54,000
A1	9,900
A2	14,700
d3	27,200
U	36,800

WEIGHT, KG

0,470

Bearing	YET 203-010
Housing	FY 503 U

MANUFACTURER

[SKF](#)

CALCULATION DATA

Basic dynamic load rating, C	9,560 kN
Basic static load rating, Co	4,750 kN
Fatigue load limit, Pu	0,200 kN
Limiting speed	9500 r/min