

## FY 1.1/2 FM SKF

Ball bearing units

TYPE: Housing units, Four-bolt flanged housing units, Cast iron housing, Radial insert ball bearing with eccentric locking collar, Type FY..FM (SKF), inch

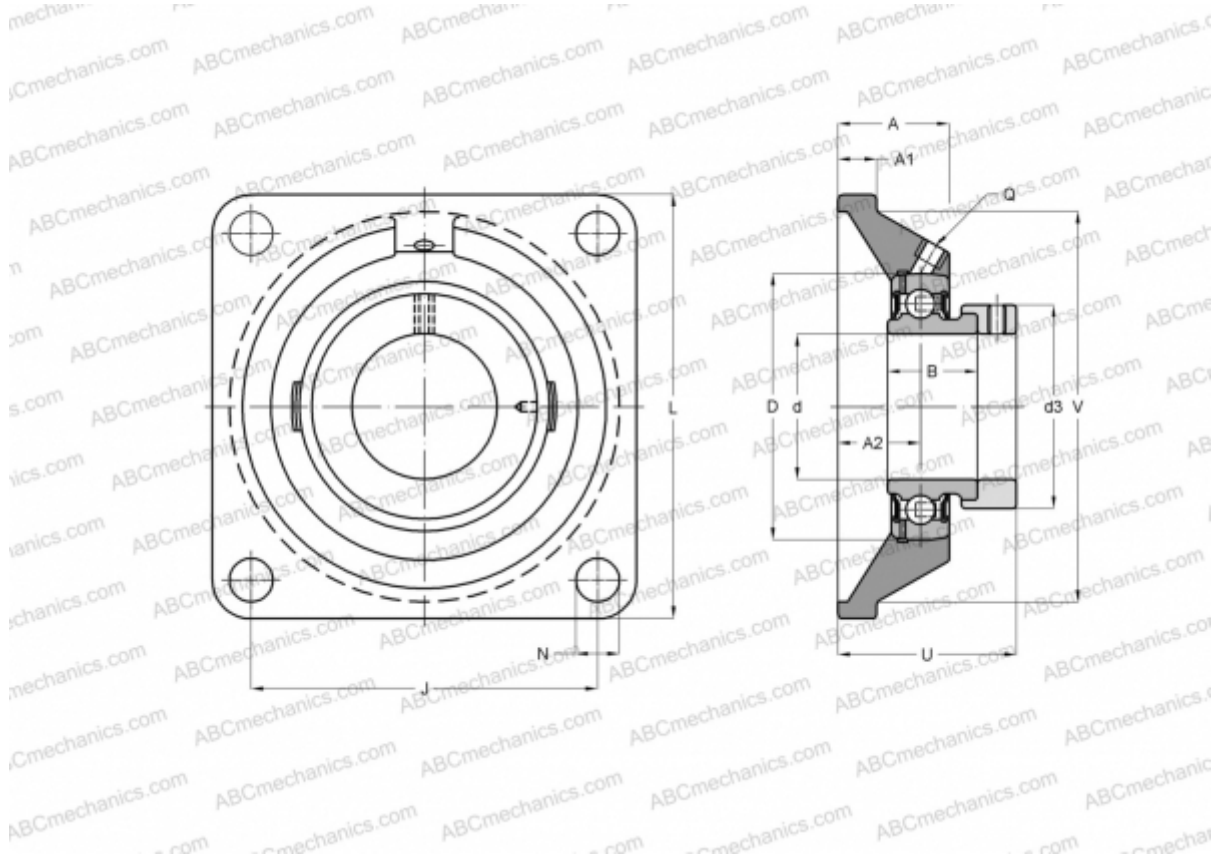

### Technical specification

#### DIMENSIONS, MM

d	38,100
D	80,000
B	43,700
L	130,000
A	38,500
J	101,500
A1	14,000
A2	23,800
d3	56,500
U	56,500

#### WEIGHT, KG

2,000

Bearing	YET 208-108
Housing	FY 508 U

#### MANUFACTURER

[SKF](#)

#### CALCULATION DATA

Basic dynamic load rating, C	30,700 kN
Basic static load rating, Co	19,000 kN
Fatigue load limit, Pu	0,800 kN
Limiting speed	4800 r/min