

FY 1.3/4 FM SKF

Ball bearing units

TYPE: Housing units, Four-bolt flanged housing units, Cast iron housing, Radial insert ball bearing with eccentric locking collar, Type FY..FM (SKF), inch

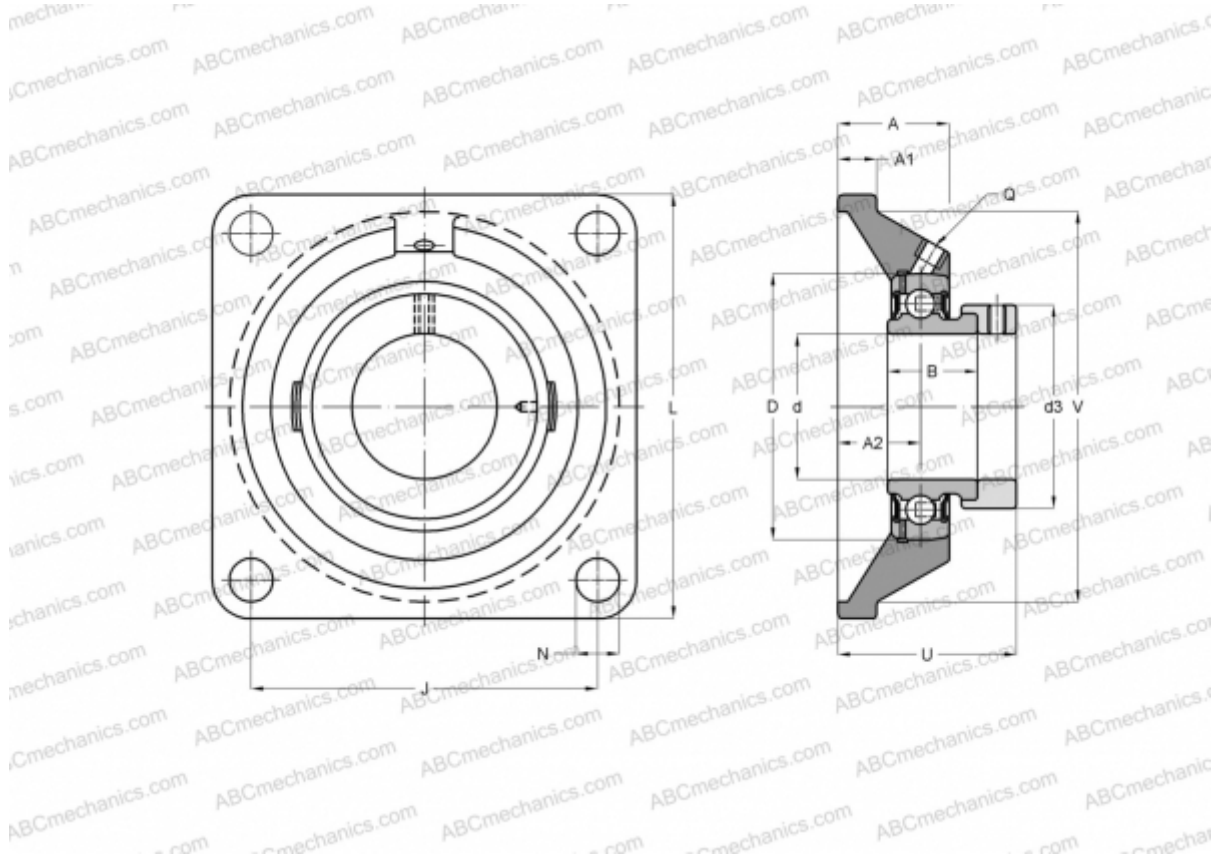

Technical specification

DIMENSIONS, MM

d	44,450
D	85,000
B	43,700
L	137,000
A	39,000
J	105,000
A1	14,000
A2	23,800
d3	62,000
U	56,500

WEIGHT, KG

2,150

Bearing	YET 209-112
Housing	FY 509 U

MANUFACTURER

[SKF](#)

CALCULATION DATA

Basic dynamic load rating, C	33,200 kN
Basic static load rating, Co	21,600 kN
Fatigue load limit, Pu	0,915 kN
Limiting speed	4300 r/min