

FY 1.15/16 FM SKF

Ball bearing units

TYPE: Housing units, Four-bolt flanged housing units, Cast iron housing, Radial insert ball bearing with eccentric locking collar, Type FY..FM (SKF), inch

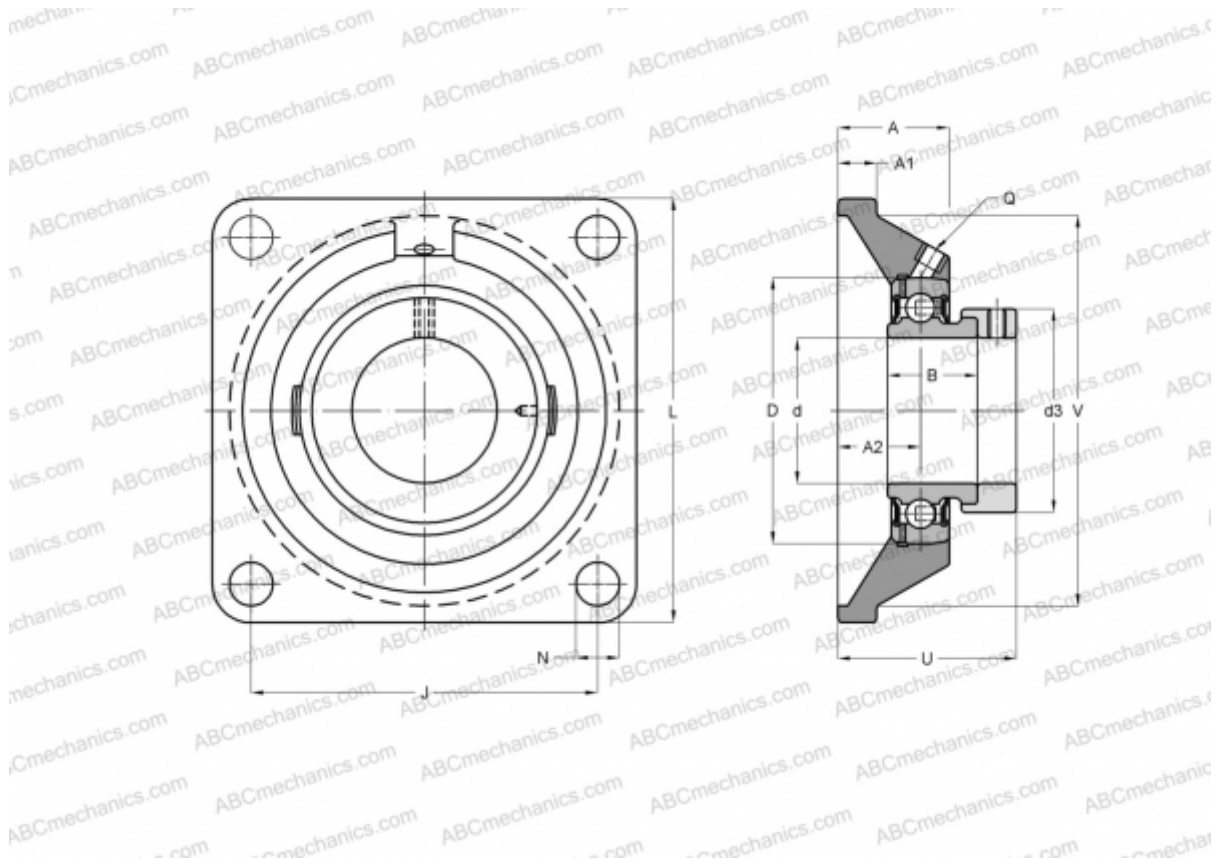

Technical specification

DIMENSIONS, MM

d	49,213
D	90,000
B	43,700
L	143,000
A	43,000
J	111,000
A1	15,000
A2	28,000
d3	67,200
U	60,700

WEIGHT, KG

2,550

Bearing	YET 210-115
Housing	FY 510 U

MANUFACTURER

[SKF](#)

CALCULATION DATA

Basic dynamic load rating, C	35,100 kN
Basic static load rating, Co	23,200 kN
Fatigue load limit, Pu	0,980 kN
Limiting speed	4000 r/min