

FY 2.3/16 WF SKF

Ball bearing units

TYPE: Housing units, Four-bolt flanged housing units, Cast iron housing, Radial insert ball bearing with eccentric locking collar, Type FY..WF (SKF), inch

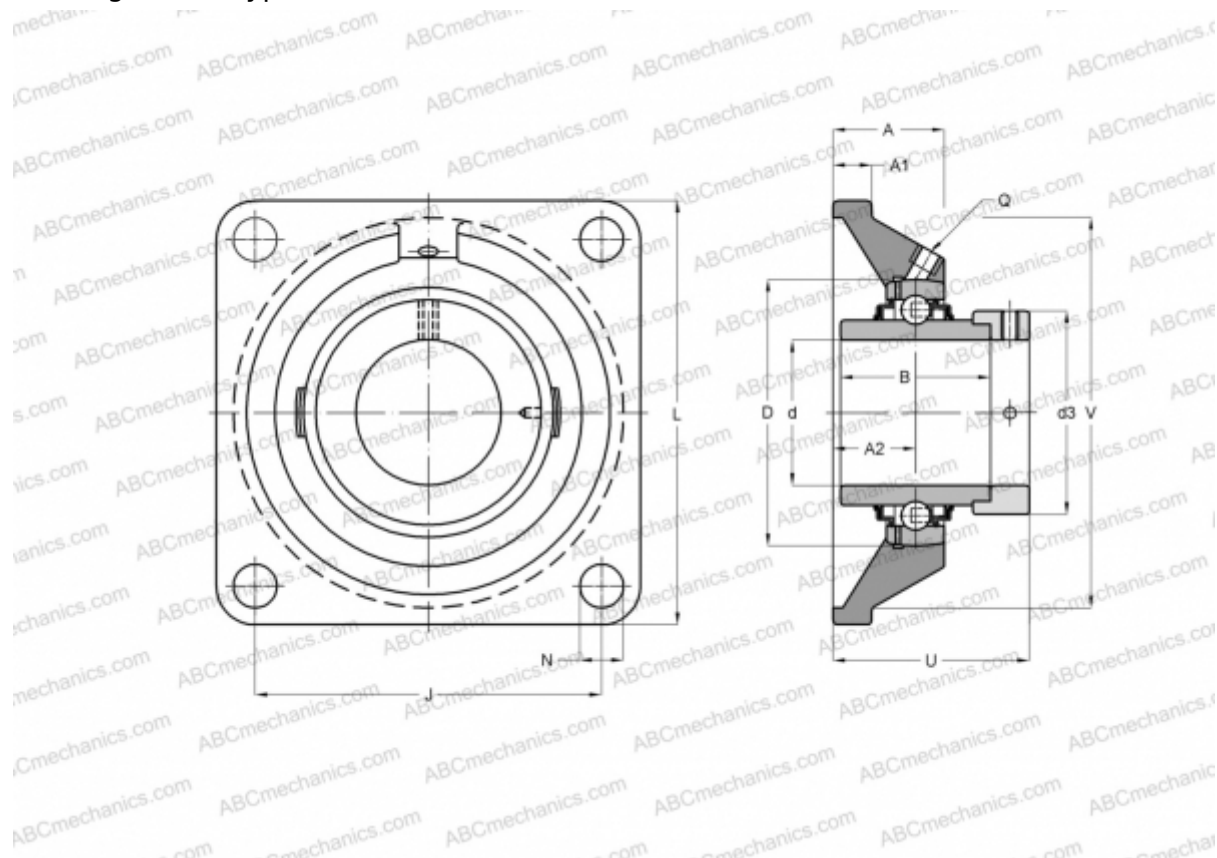

Technical specification

DIMENSIONS, MM

d	55,563
D	100,000
B	71,400
L	162,000
A	47,500
J	130,000
A1	16,000
A2	31,000
d3	74,500
U	74,600

WEIGHT, KG 3,850

Bearing	YEL 211-203-2F
Housing	FY 511 U

MANUFACTURER

[SKF](#)

CALCULATION DATA

Basic dynamic load rating, C	43,600 kN
Basic static load rating, Co	29,000 kN
Fatigue load limit, Pu	1,250 kN
Limiting speed	3600 r/min