

FYTB 25 TF SKF

Ball bearing units

TYPE: Housing units, Two-bolt flanged housing units, Cast iron housing, Radial insert ball bearing with grub screws in inner ring, Type FYTB/FYTJ..TF (SKF)

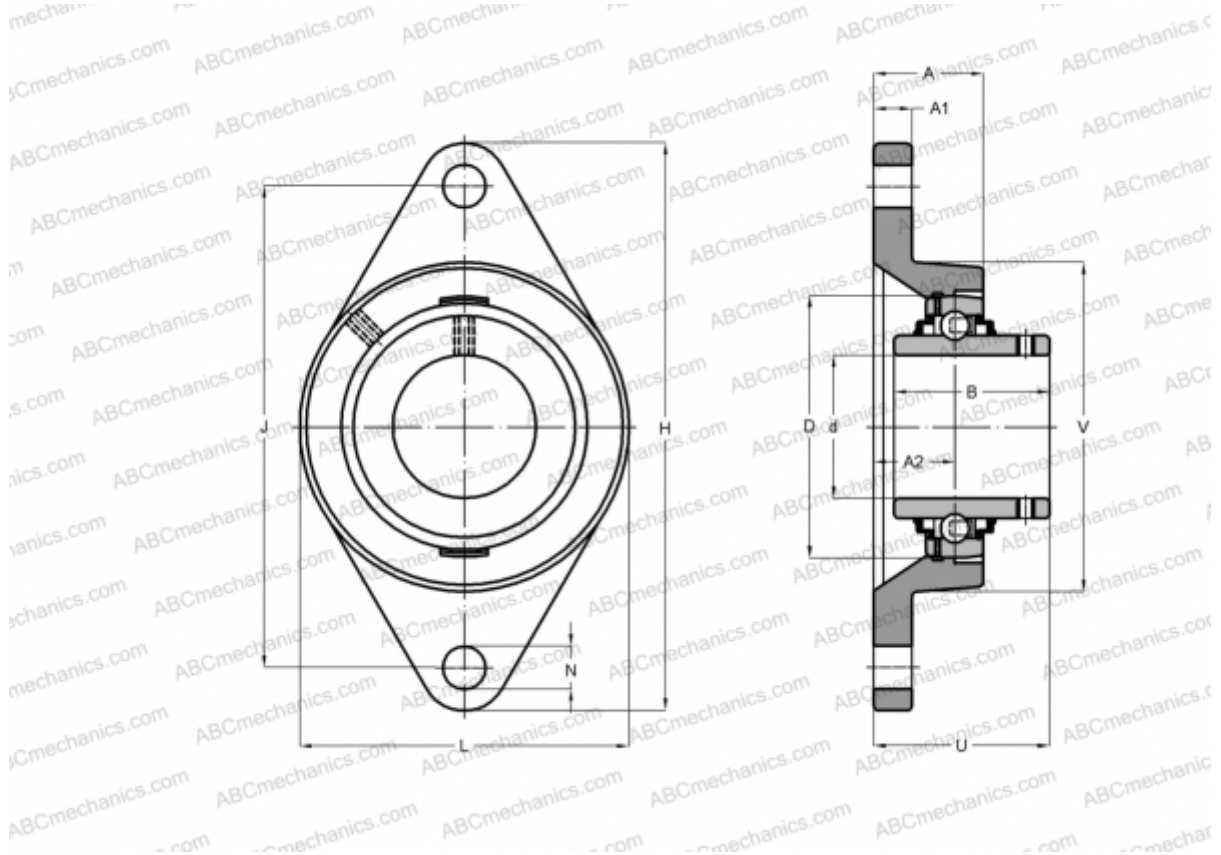

Technical specification

DIMENSIONS, MM

d	25,000
D	52,000
B	34,100
L	70,000
H	124,000
A	30,000
J	99,000
A1	12,000
A2	19,000
N	11,500
U	38,800
V	63,500

WEIGHT, KG 0,630

Bearing	YAR 205-2F
Housing	FYTB 505 M
Protective cover	ECY 205

MANUFACTURER

[SKF](#)

CALCULATION DATA

Basic dynamic load rating, C	14,000 kN
Basic static load rating, Co	7,800 kN
Fatigue load limit, Pu	0,335 kN
Limiting speed	7000 r/min