

FYTB 20 TR SKF

Ball bearing units

TYPE: Housing units, Two-bolt flanged housing units, Cast iron housing, Radial insert ball bearing with grub screws in inner ring, Type FYTB..TR (SKF)

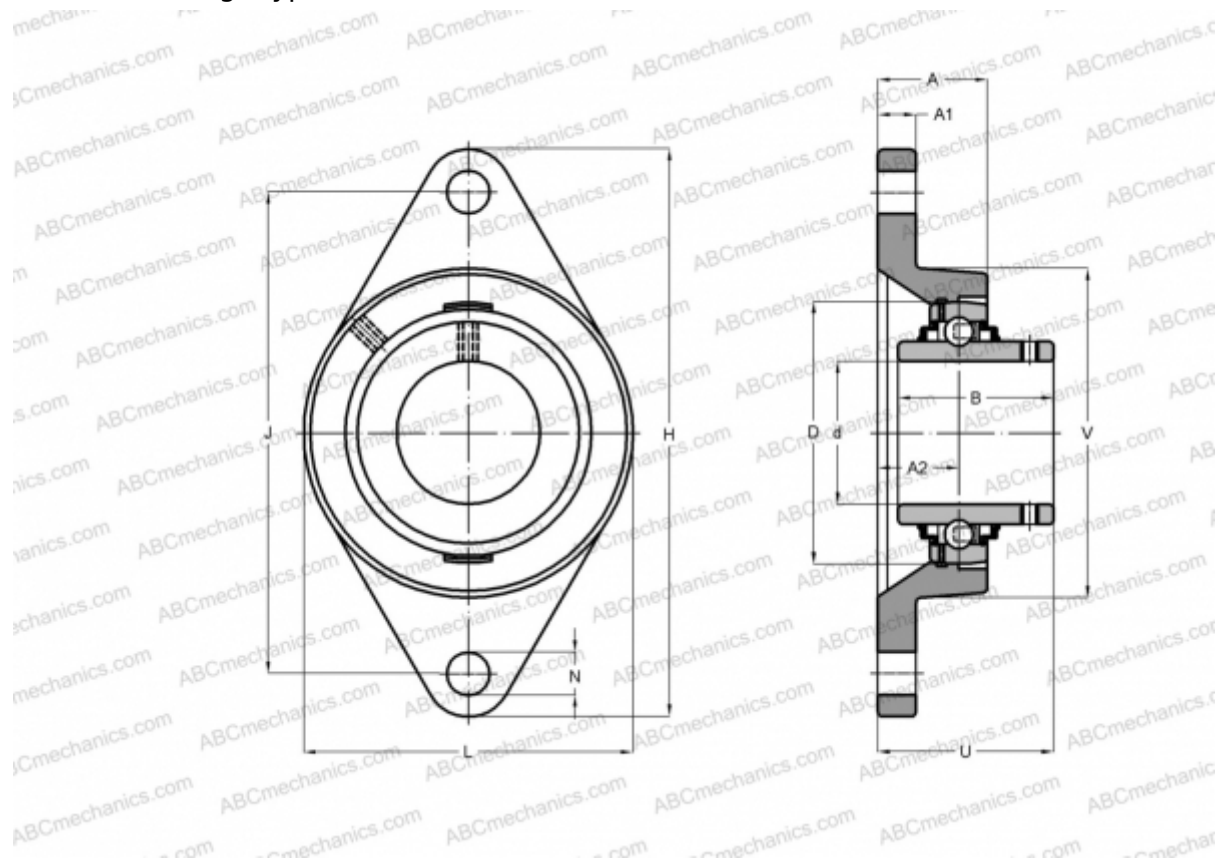

Technical specification

DIMENSIONS, MM

d	20,000
D	47,000
B	31,000
L	60,500
H	112,000
A	29,500
J	90,000
A1	11,000
A2	19,000
N	11,500
U	37,300
V	50,800

WEIGHT, KG 0,500

Bearing	YAR 204-2RF
Housing	FYTB 504 M
Protective cover	ECY 204

MANUFACTURER

[SKF](#)

CALCULATION DATA

Basic dynamic load rating, C	12,700 kN
Basic static load rating, Co	6,550 kN
Fatigue load limit, Pu	0,280 kN
Limiting speed	5000 r/min