

FYT 1.3/4 TF SKF

Ball bearing units

TYPE: Housing units, Two-bolt flanged housing units, Cast iron housing, Radial insert ball bearing with grub screws in inner ring, Type FYT/FYTB/FYTJ..TF (SKF), inch

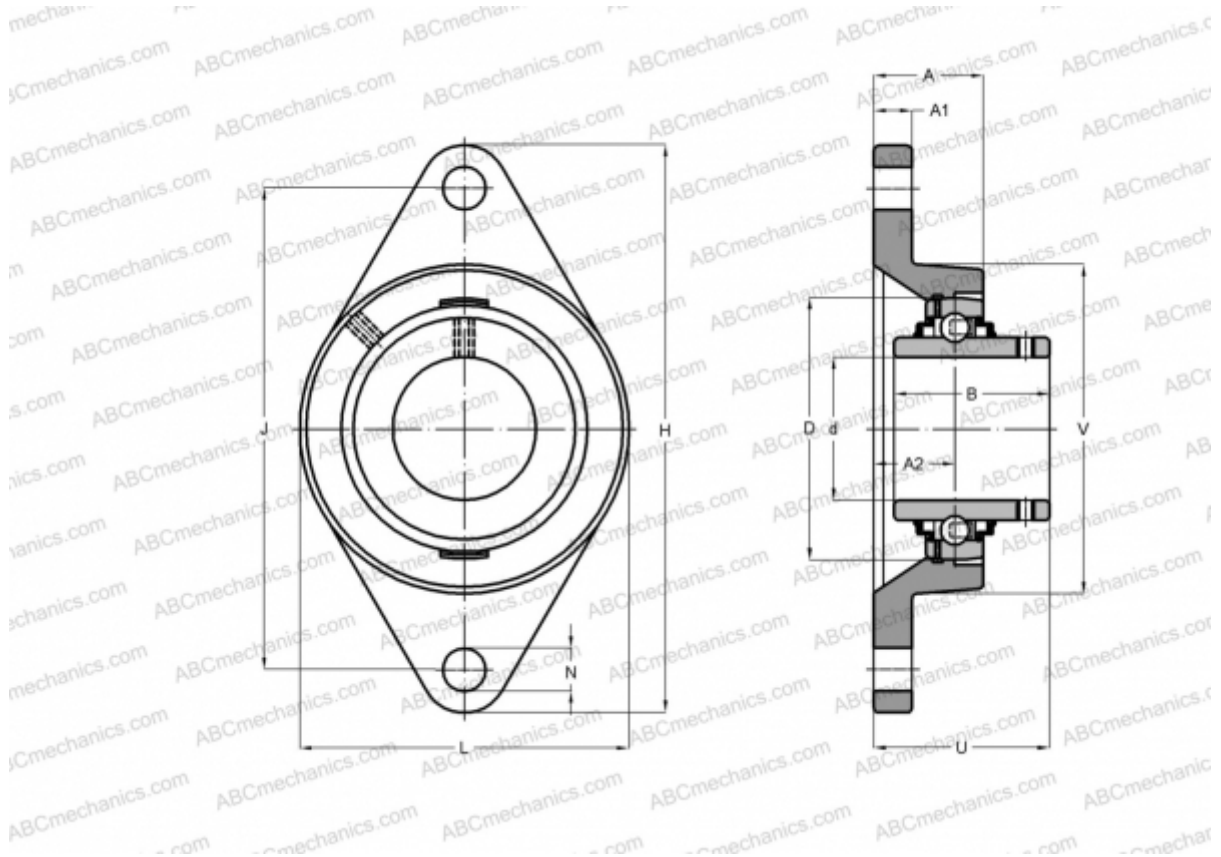

Technical specification

DIMENSIONS, MM

d	44,450
D	85,000
B	49,200
L	111,000
H	178,500
A	39,000
J	148,400
A1	14,000
A2	24,000
N	15,900
U	54,200

WEIGHT, KG

1,800

Bearing

YAR 209-112-2F

Housing

FYT 509 U

MANUFACTURER

[SKF](#)

CALCULATION DATA

Basic dynamic load rating, C	33,200 kN
Basic static load rating, Co	21,600 kN
Fatigue load limit, Pu	0,915 kN
Limiting speed	4300 r/min