

FYT 2. TF SKF

Ball bearing units

TYPE: Housing units, Two-bolt flanged housing units, Cast iron housing, Radial insert ball bearing with grub screws in inner ring, Type FYT/FYTB/FYTJ..TF (SKF), inch

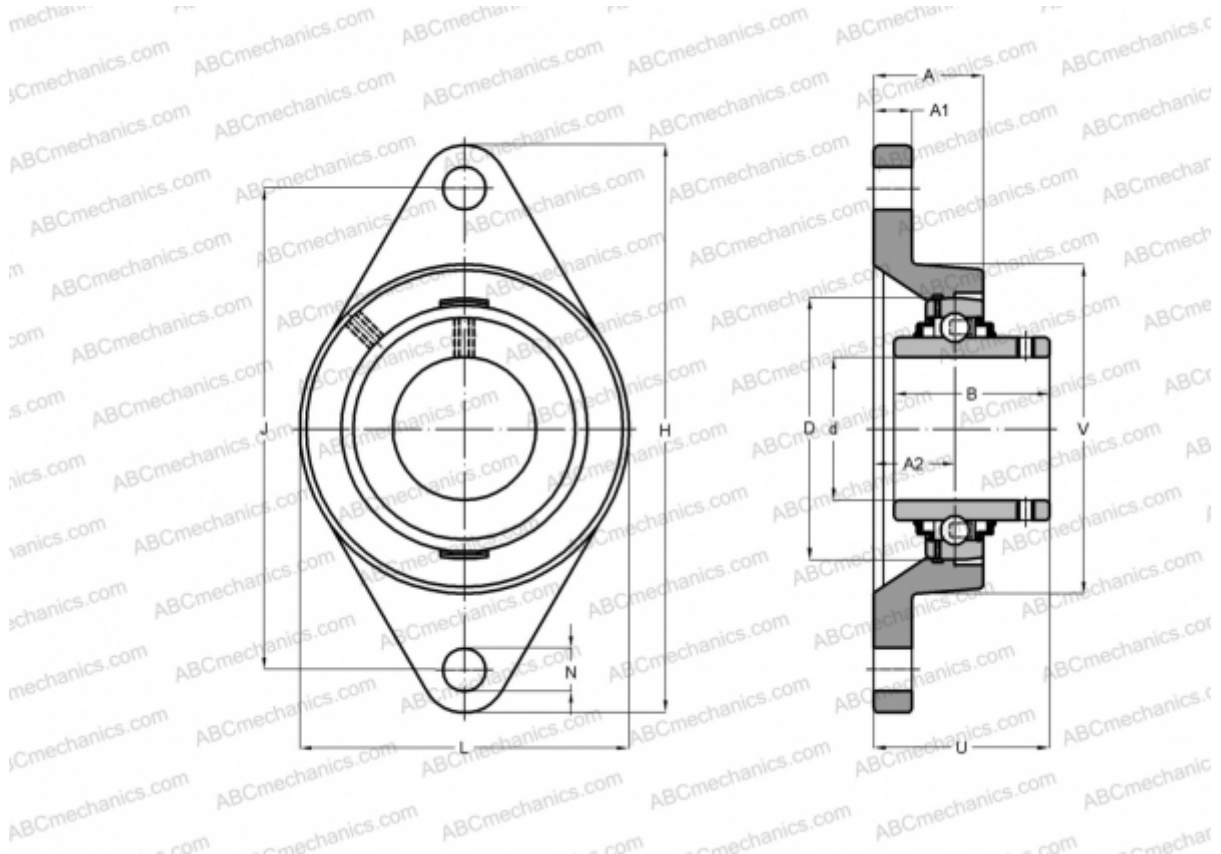

Technical specification

DIMENSIONS, MM

d	50,800
D	100,000
B	55,600
L	127,000
H	216,000
A	47,600
J	184,200
A1	20,600
A2	29,400
N	19,000
U	62,800

WEIGHT, KG

3,450

Bearing

YAR 211-200-2F

Housing

FYT 511 U

MANUFACTURER

[SKF](#)

CALCULATION DATA

Basic dynamic load rating, C	43,600 kN
Basic static load rating, Co	29,000 kN
Fatigue load limit, Pu	1,250 kN
Limiting speed	3600 r/min