

FYT 5/8 RM SKF

Ball bearing units

TYPE: Housing units, Two-bolt flanged housing units, Cast iron housing, Radial insert ball bearing with grub screws in inner ring, Type FYT..RM (SKF), inch

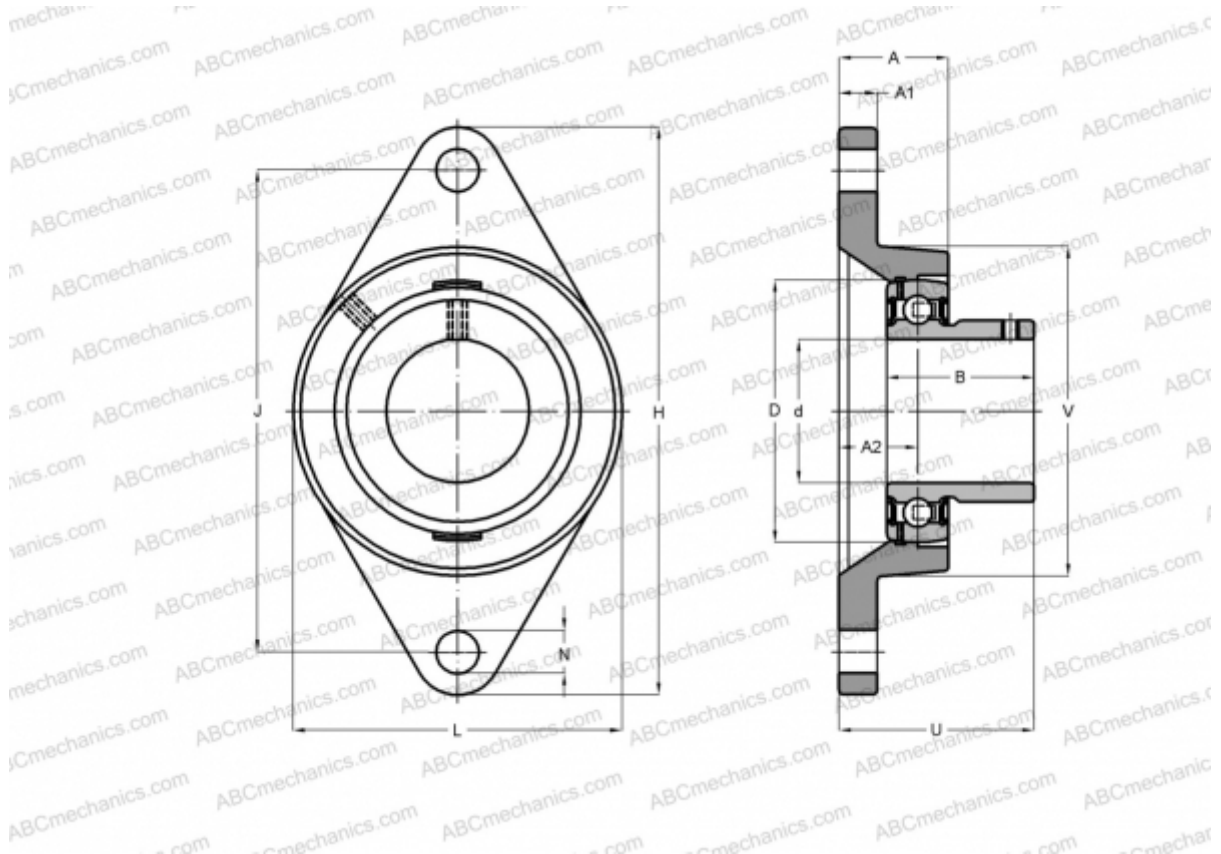

Technical specification

DIMENSIONS, MM

d	15,875
D	40,000
B	22,500
L	54,000
H	98,500
A	23,400
J	76,200
A1	11,500
A2	14,600
N	11,100
U	30,600

WEIGHT, KG

0,300

Bearing

YAT 203-010

Housing

FYT 503 U

MANUFACTURER

[SKF](#)

CALCULATION DATA

Basic dynamic load rating, C	9,560 kN
Basic static load rating, Co	4,750 kN
Fatigue load limit, Pu	0,200 kN
Limiting speed	9500 r/min