

FYT 1.1/4 RM SKF

Ball bearing units

TYPE: Housing units, Two-bolt flanged housing units, Cast iron housing, Radial insert ball bearing with grub screws in inner ring, Type FYT..RM (SKF), inch

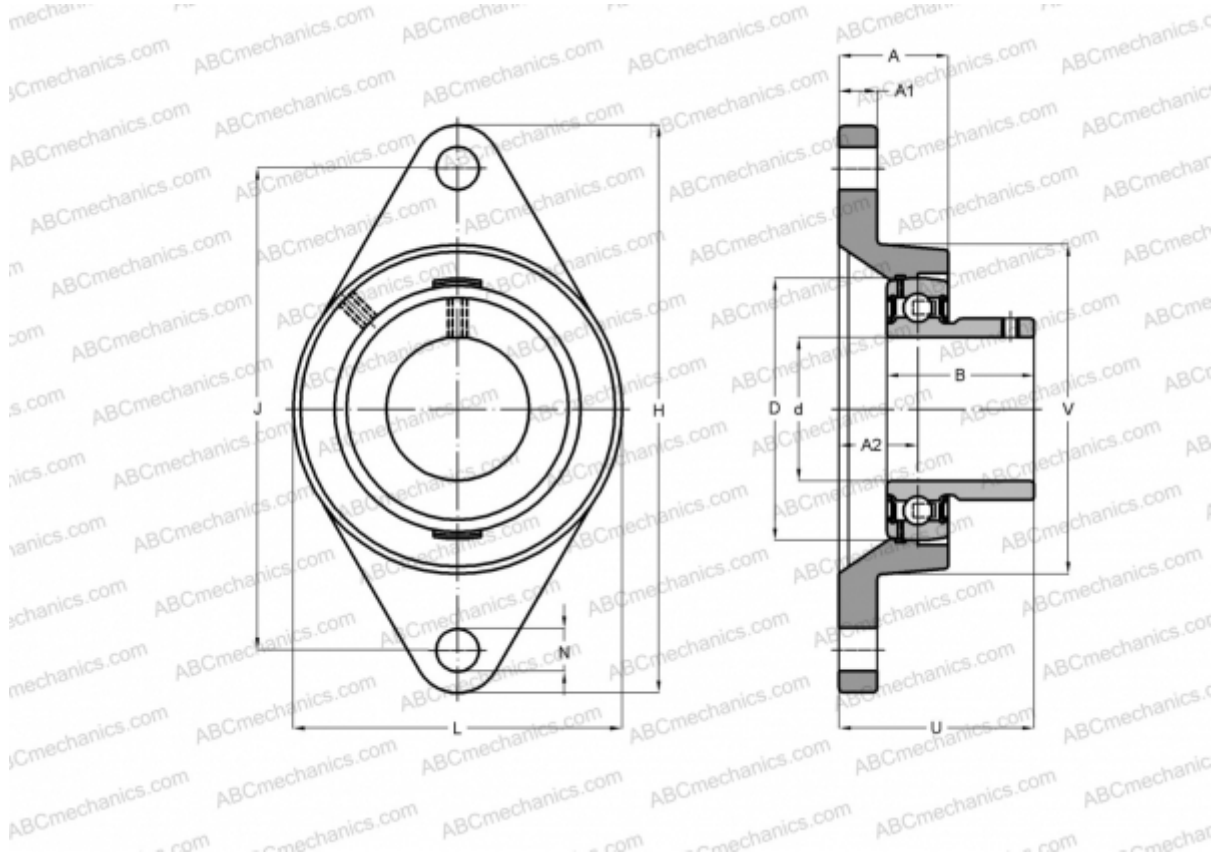

Technical specification

DIMENSIONS, MM

d	31,750
D	72,000
B	35,000
L	96,000
H	156,000
A	34,500
J	130,200
A1	13,000
A2	20,900
N	14,300
U	46,400

WEIGHT, KG 1,210

Bearing YAT 207-104

Housing FYT 507 U

MANUFACTURER

[SKF](#)

CALCULATION DATA

Basic dynamic load rating, C	25,500 kN
Basic static load rating, Co	15,300 kN
Fatigue load limit, Pu	0,655 kN
Limiting speed	5300 r/min