

FYT 1.1/2 RM SKF

Ball bearing units

TYPE: Housing units, Two-bolt flanged housing units, Cast iron housing, Radial insert ball bearing with grub screws in inner ring, Type FYT..RM (SKF), inch

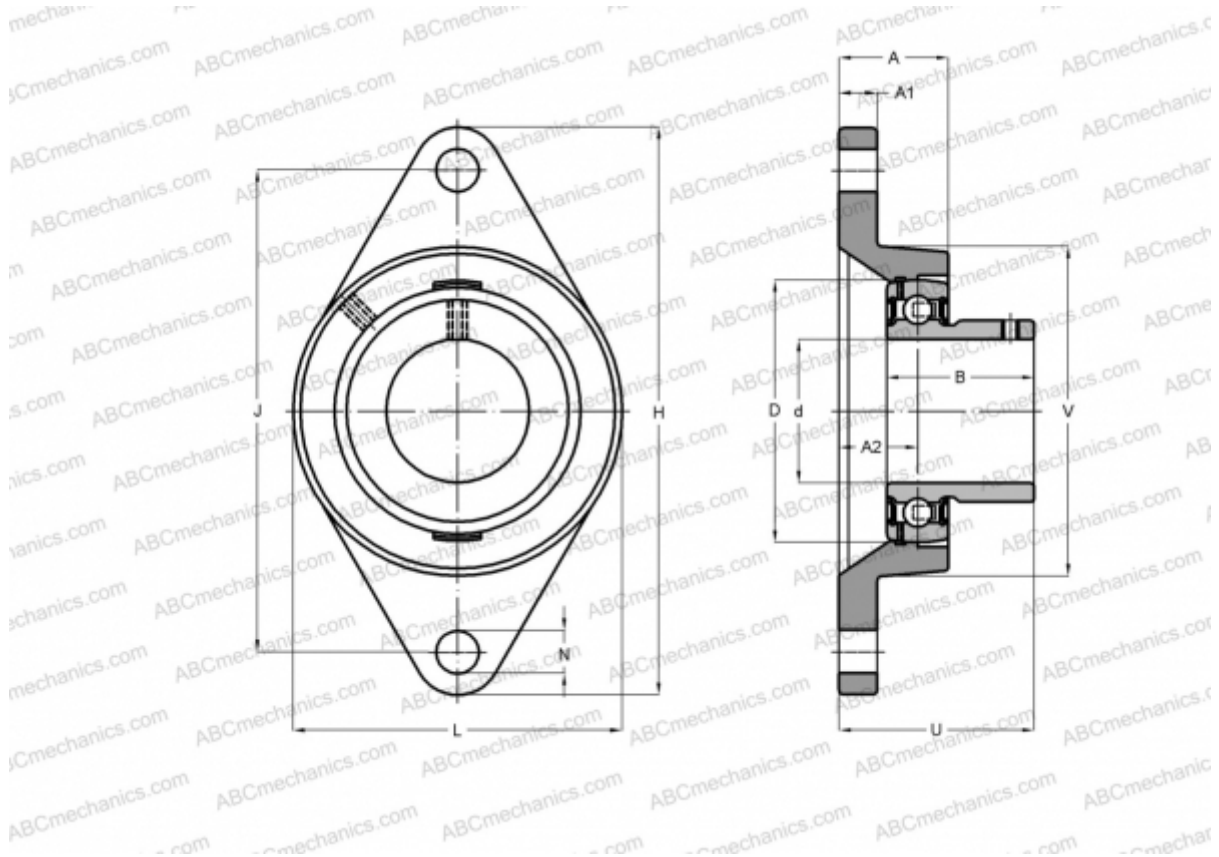

Technical specification

DIMENSIONS, MM

d	38,100
D	80,000
B	40,000
L	102,000
H	171,500
A	38,500
J	143,700
A1	14,000
A2	24,100
N	14,300
U	52,600

WEIGHT, KG

1,600

Bearing

YAT 208-108

Housing

FYT 508 U

MANUFACTURER

[SKF](#)

CALCULATION DATA

Basic dynamic load rating, C	30,700 kN
Basic static load rating, Co	19,000 kN
Fatigue load limit, Pu	0,800 kN
Limiting speed	4800 r/min