

FYTB 45 FM SKF

Ball bearing units

TYPE: Housing units, Two-bolt flanged housing units, Cast iron housing, Radial insert ball bearing with eccentric locking collar, Type FYTB..FM (SKF)

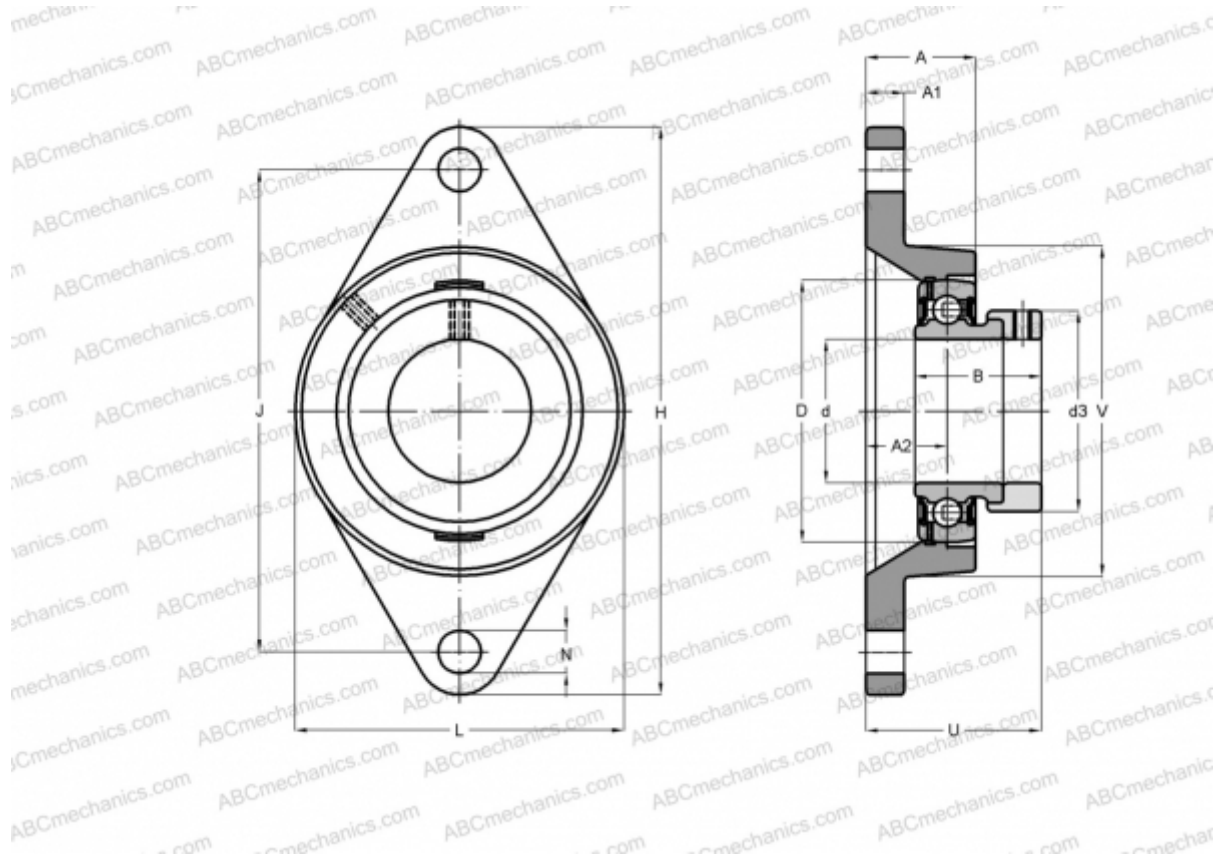

Technical specification

DIMENSIONS, MM

d	45,000
D	85,000
B	43,700
L	111,000
H	178,500
A	39,000
J	148,500
A1	14,000
A2	32,700
N	16,000
d3	62,000
U	56,700
V	98,400

Bearing	YET 209
Housing	FYTB 509 M
Protective cover	ECY 209

MANUFACTURER

[SKF](#)

CALCULATION DATA

Basic dynamic load rating, C	33,200 kN
Basic static load rating, Co	21,600 kN
Fatigue load limit, Pu	0,915 kN
Limiting speed	4300 r/min

WEIGHT, KG 1,850