

FYT 1/2 FM SKF

Ball bearing units

TYPE: Housing units, Two-bolt flanged housing units, Cast iron housing, Radial insert ball bearing with eccentric locking collar, Type FYT..FM (SKF), inch

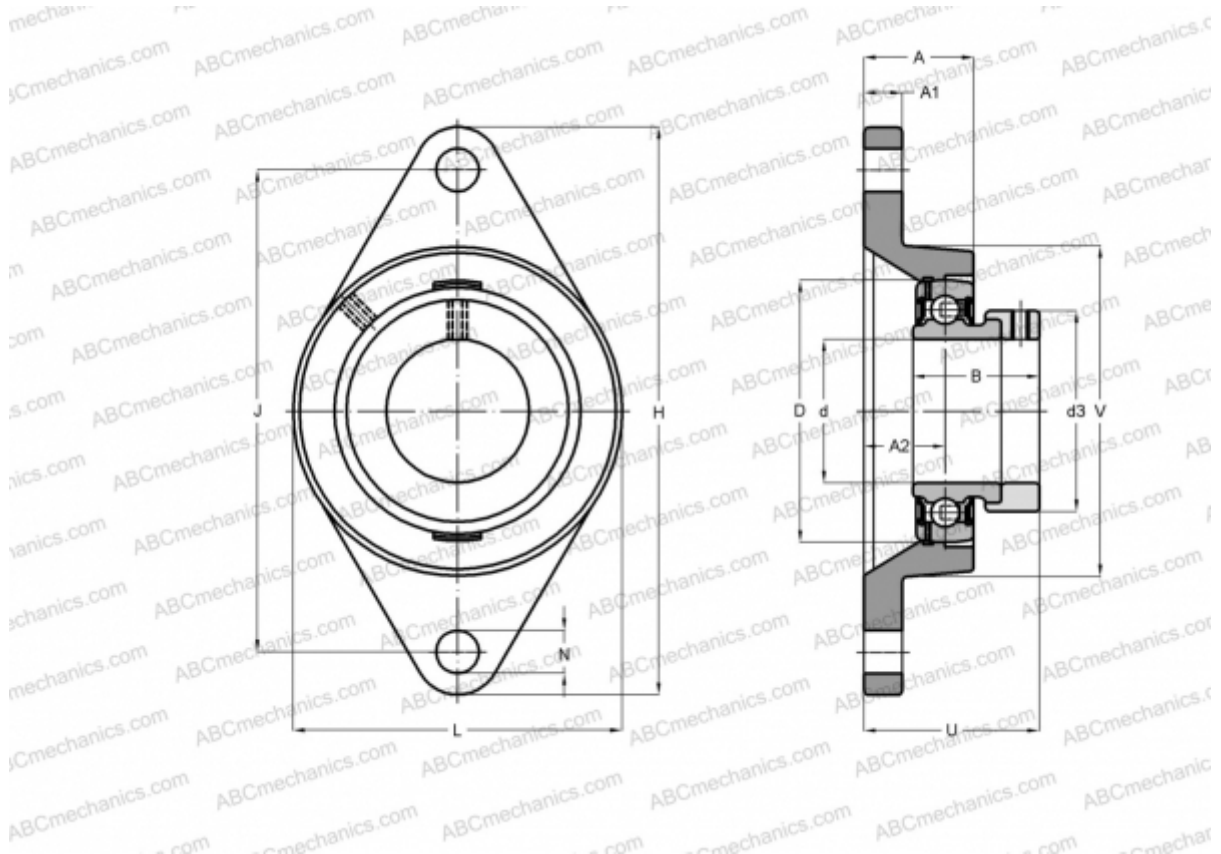

Technical specification

DIMENSIONS, MM

d	12,700
D	40,000
B	26,600
L	54,000
H	98,500
A	23,400
J	76,200
A1	11,500
A2	14,700
N	11,100
d3	27,200
U	36,800

WEIGHT, KG 0,350

Bearing	YET 203-008
Housing	FYT 503 U

MANUFACTURER

[SKF](#)

CALCULATION DATA

Basic dynamic load rating, C	9,560 kN
Basic static load rating, Co	4,750 kN
Fatigue load limit, Pu	0,200 kN
Limiting speed	9500 r/min