

FYT 3/4 FM SKF

Ball bearing units

TYPE: Housing units, Two-bolt flanged housing units, Cast iron housing, Radial insert ball bearing with eccentric locking collar, Type FYT..FM (SKF), inch

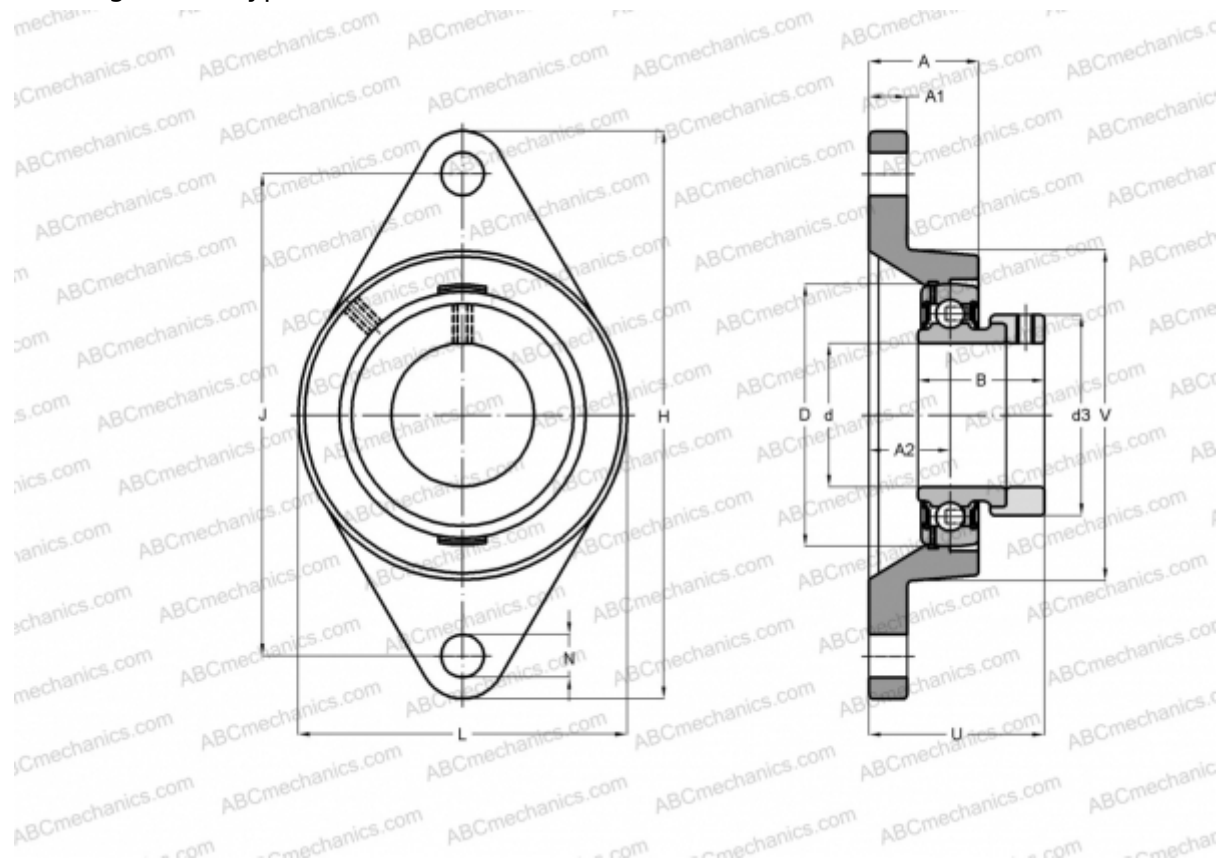

Technical specification

DIMENSIONS, MM

d	19,050
D	47,000
B	31,000
L	60,300
H	112,000
A	24,600
J	89,700
A1	11,100
A2	14,300
N	11,100
d3	32,400
U	37,800

WEIGHT, KG 0,530

Bearing	YET 204-012
Housing	FYT 504 U

MANUFACTURER

[SKF](#)

CALCULATION DATA

Basic dynamic load rating, C	12,700 kN
Basic static load rating, Co	6,550 kN
Fatigue load limit, Pu	0,280 kN
Limiting speed	8500 r/min