

## FYT 1.3/4 FM SKF

Ball bearing units

TYPE: Housing units, Two-bolt flanged housing units, Cast iron housing, Radial insert ball bearing with eccentric locking collar, Type FYT..FM (SKF), inch

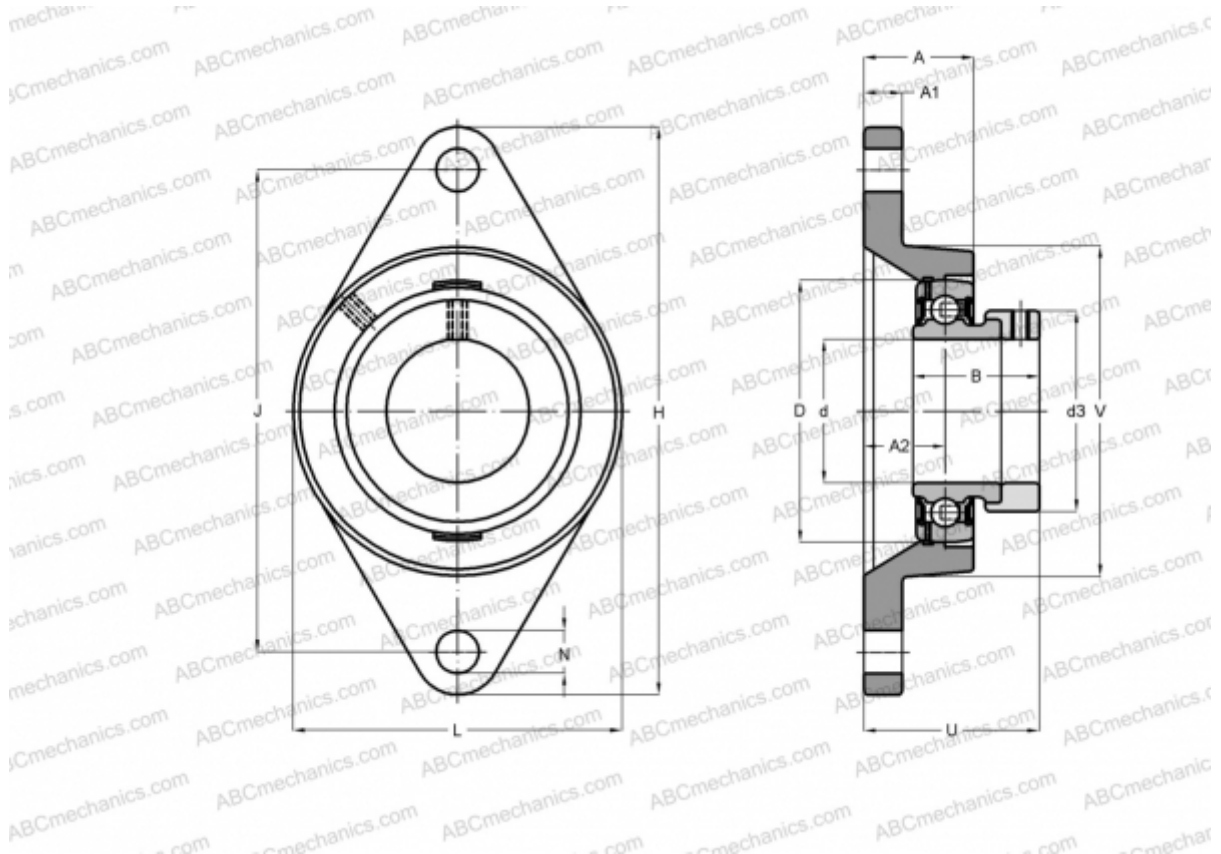

### Technical specification

#### DIMENSIONS, MM

d	44,450
D	85,000
B	43,700
L	111,000
H	178,500
A	39,000
J	148,400
A1	14,000
A2	24,000
N	15,900
d3	62,000
U	56,700

#### WEIGHT, KG

1,850

Bearing

YET 209-112

Housing

FYT 509 U

#### MANUFACTURER

[SKF](#)

#### CALCULATION DATA

Basic dynamic load rating, C	33,200 kN
Basic static load rating, Co	21,600 kN
Fatigue load limit, Pu	0,915 kN
Limiting speed	4300 r/min