

FYTJ 35 KF SKF

Ball bearing units

TYPE: Housing units, Two-bolt flanged housing units, Cast iron housing, Radial insert ball bearing with adapter sleeve, Type FYTJ..KF (SKF)

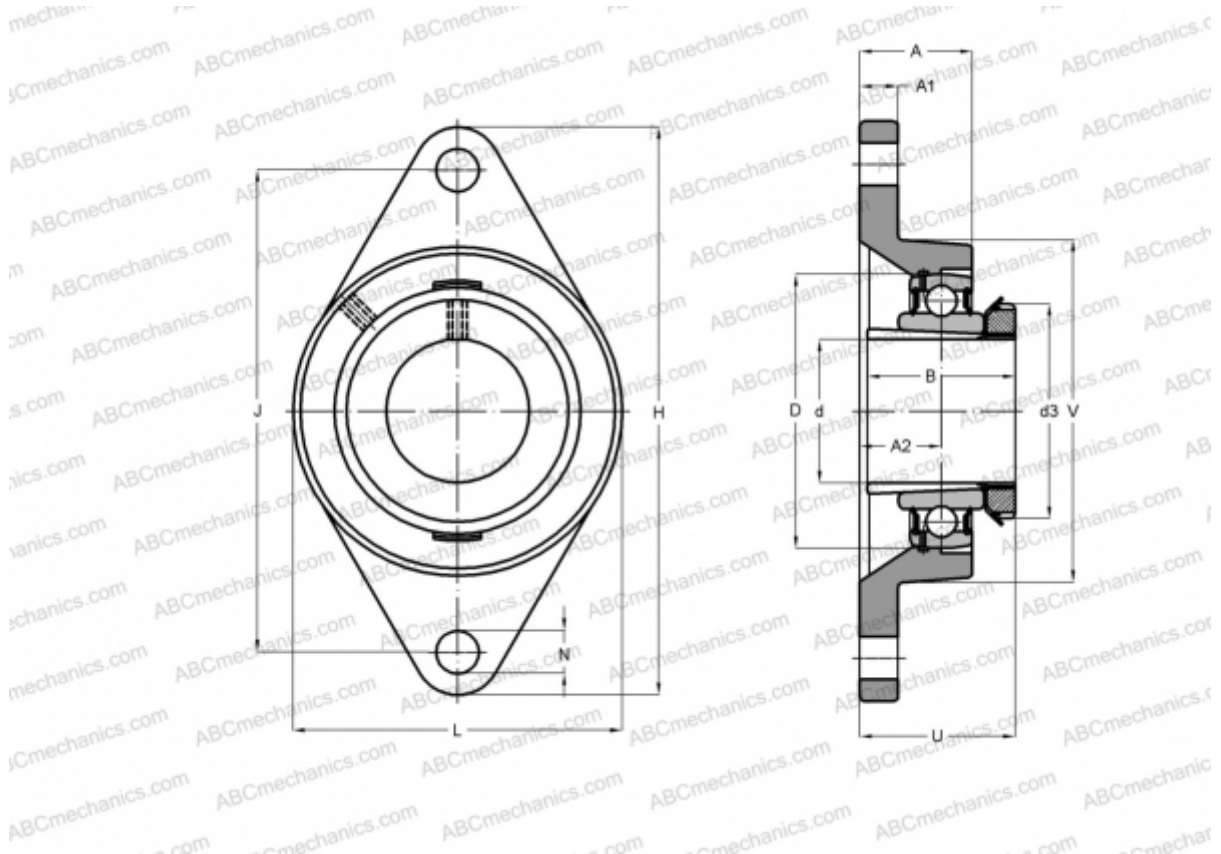

Technical specification

DIMENSIONS, MM

d	30,000
D	72,000
B	43,000
L	96,000
H	161,000
A	34,000
J	130,000
A1	16,000
A2	19,000
N	16,000
d3	52,000
U	43,300
V	88,900

Bearing	YSA 207-2FK
Housing	FYTJ 507
Adapter sleeve	H 2307

MANUFACTURER

[SKF](#)

CALCULATION DATA

Basic dynamic load rating, C	25,500 kN
Basic static load rating, Co	15,300 kN
Fatigue load limit, Pu	0,655 kN
Limiting speed	5300 r/min

WEIGHT, KG 1,300