

FYTJ 45 KF SKF

Ball bearing units

TYPE: Housing units, Two-bolt flanged housing units, Cast iron housing, Radial insert ball bearing with adapter sleeve, Type FYTJ..KF (SKF)

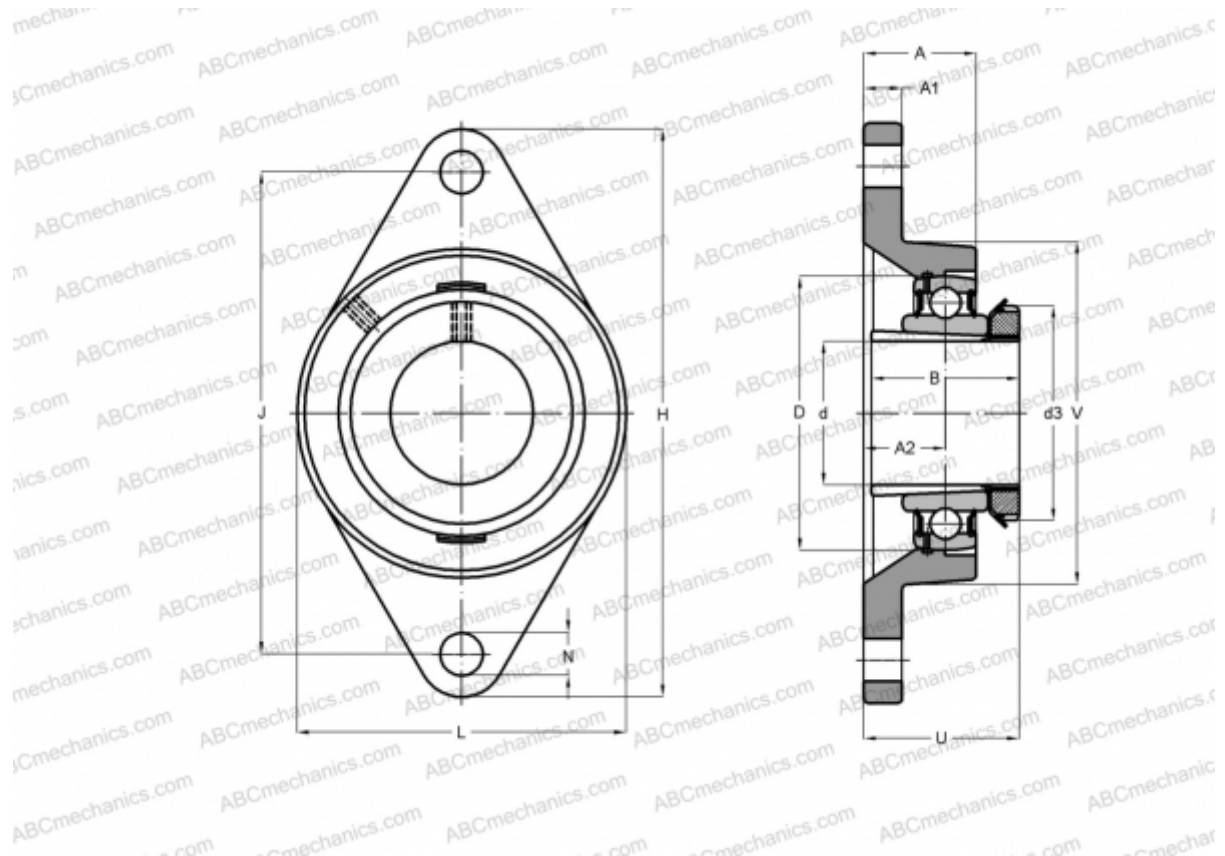

Technical specification

DIMENSIONS, MM

d	40,000
D	85,000
B	50,000
L	108,000
H	188,000
A	38,000
J	148,000
A1	18,000
A2	22,000
N	19,000
d3	65,000
U	50,500
V	98,400

WEIGHT, KG 2,200

Bearing	YSA 209-2FK
Housing	FYTJ 509
Adapter sleeve	H 2309

MANUFACTURER

[SKF](#)

CALCULATION DATA

Basic dynamic load rating, C	33,200 kN
Basic static load rating, Co	21,600 kN
Fatigue load limit, Pu	0,915 kN
Limiting speed	4300 r/min