

FYTJ 30 KF SKF

Ball bearing units

TYPE: Housing units, Two-bolt flanged housing units, Cast iron housing, Radial insert ball bearing with adapter sleeve, Type FYTJ..KF (SKF), inch

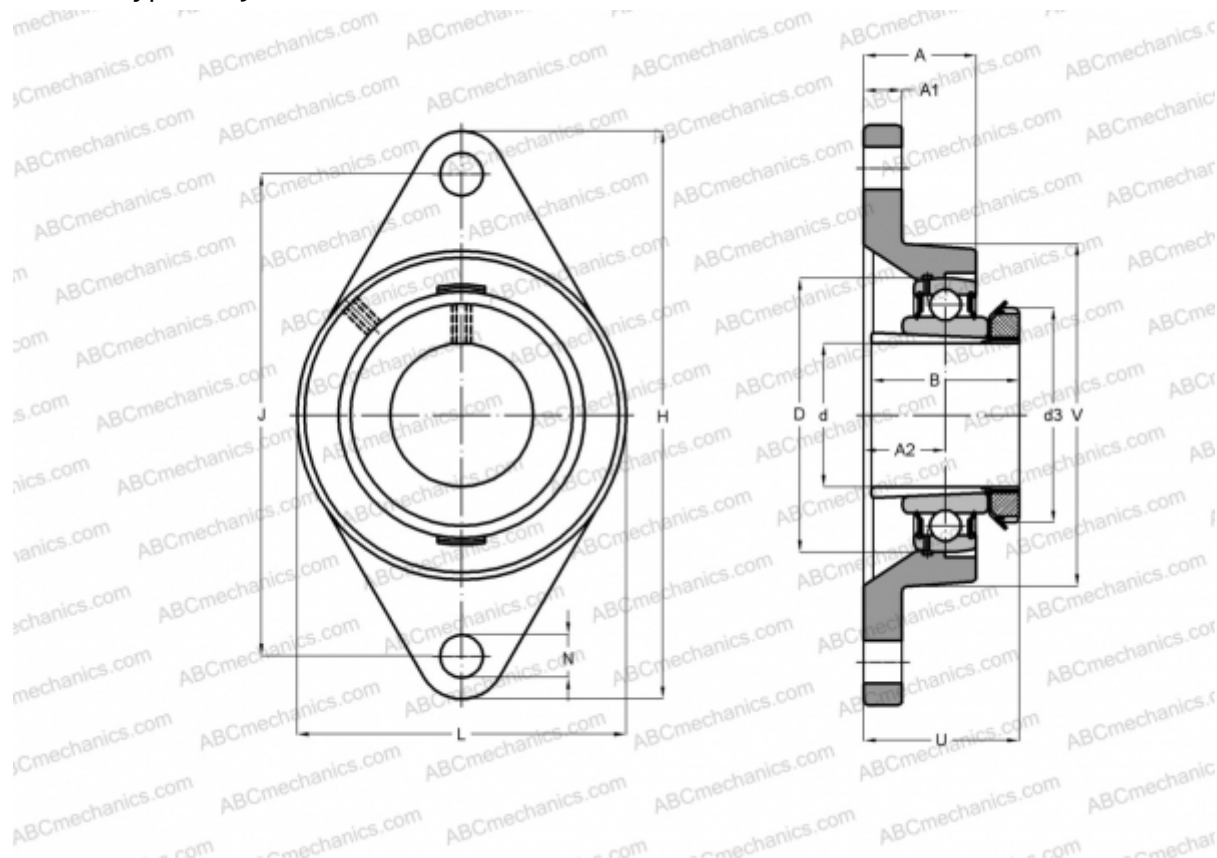

Technical specification

DIMENSIONS, MM

d	25,400
D	62,000
B	38,000
L	80,000
H	148,000
A	30,500
J	117,000
A1	13,500
A2	18,000
N	16,000
d3	45,000
U	40,000
V	76,200

WEIGHT, KG 0,830

Bearing	YSA 206-2FK
Housing	FYTJ 506
Adapter sleeve	HE 2306

MANUFACTURER

[SKF](#)

CALCULATION DATA

Basic dynamic load rating, C	19,500 kN
Basic static load rating, Co	11,200 kN
Fatigue load limit, Pu	0,475 kN
Limiting speed	6300 r/min