

FYTJ 40 KF SKF

Ball bearing units

TYPE: Housing units, Two-bolt flanged housing units, Cast iron housing, Radial insert ball bearing with adapter sleeve, Type FYTJ..KF (SKF), inch

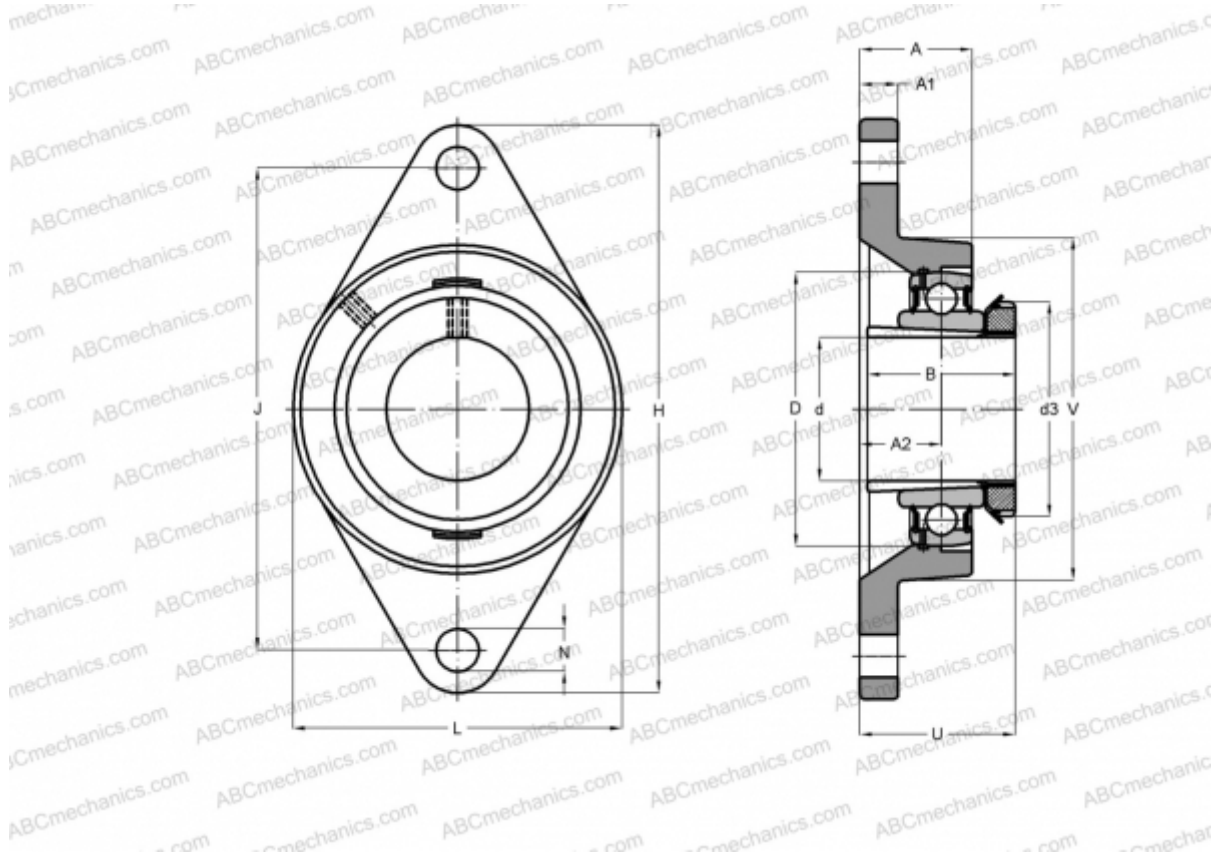

Technical specification

DIMENSIONS, MM

d	31,750
D	80,000
B	46,000
L	100,000
H	175,000
A	36,000
J	144,000
A1	16,000
A2	21,000
N	16,000
d3	58,000
U	48,000
V	88,900

Bearing	YSA 208-2FK
Housing	FYTJ 508
Adapter sleeve	HE 2308

MANUFACTURER

[SKF](#)

CALCULATION DATA

Basic dynamic load rating, C	30,700 kN
Basic static load rating, Co	19,000 kN
Fatigue load limit, Pu	0,800 kN
Limiting speed	4800 r/min

WEIGHT, KG 1,650