

FYC 30 TF SKF

Ball bearing units

TYPE: Housing units, Four-bolt flanged housing units, Cast iron housing, Radial insert ball bearing with grub screws in inner ring, Type FYC..TF (SKF)

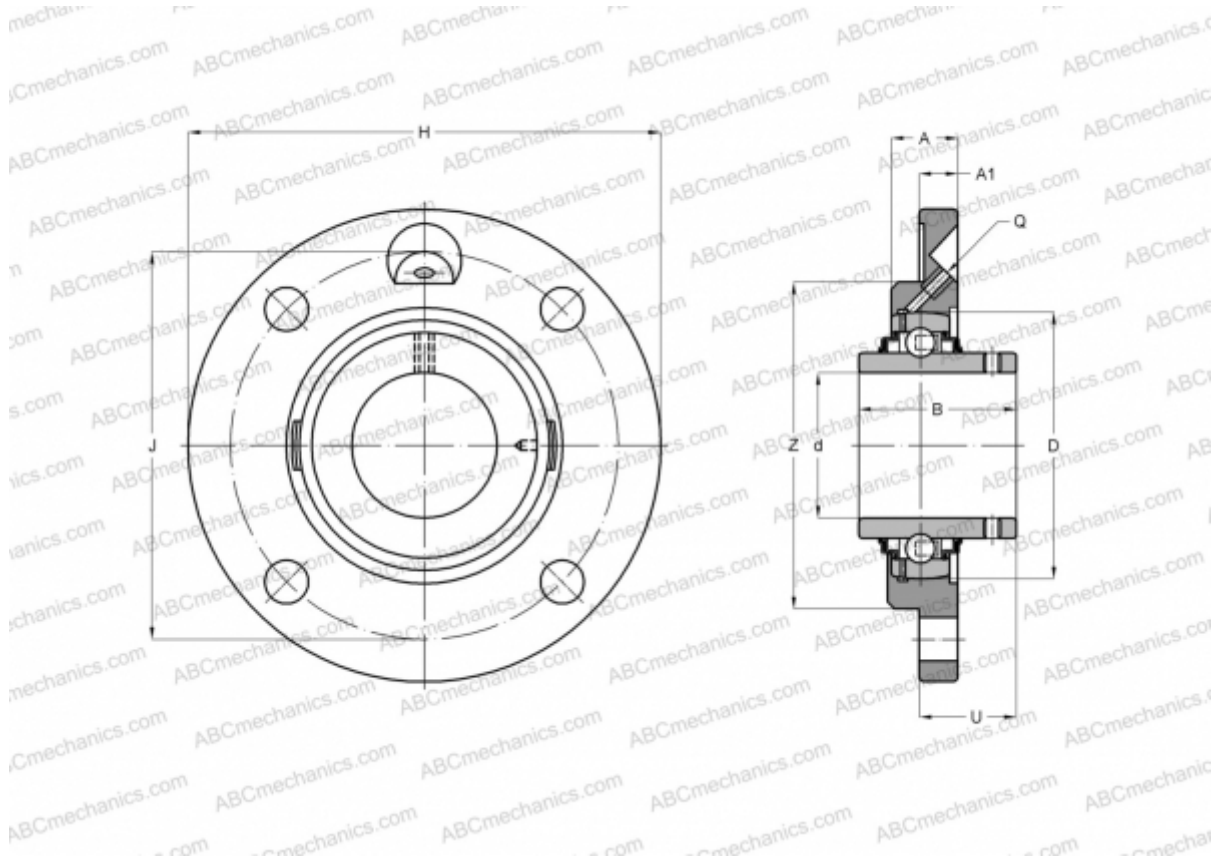

Technical specification

DIMENSIONS, MM

d	30,000
D	62,000
B	38,100
H	125,000
A	31,000
J	100,000
A1	8,000
U	32,200
Z	80,000

WEIGHT, KG

1,350

Bearing	YAR 206-2F
Housing	FYC 506

MANUFACTURER

[SKF](#)

CALCULATION DATA

Basic dynamic load rating, C	19,500 kN
Basic static load rating, Co	11,200 kN
Fatigue load limit, Pu	0,475 kN
Limiting speed	6300 r/min