

FYC 65 TF SKF

Ball bearing units

TYPE: Housing units, Four-bolt flanged housing units, Cast iron housing, Radial insert ball bearing with grub screws in inner ring, Type FYC..TF (SKF)

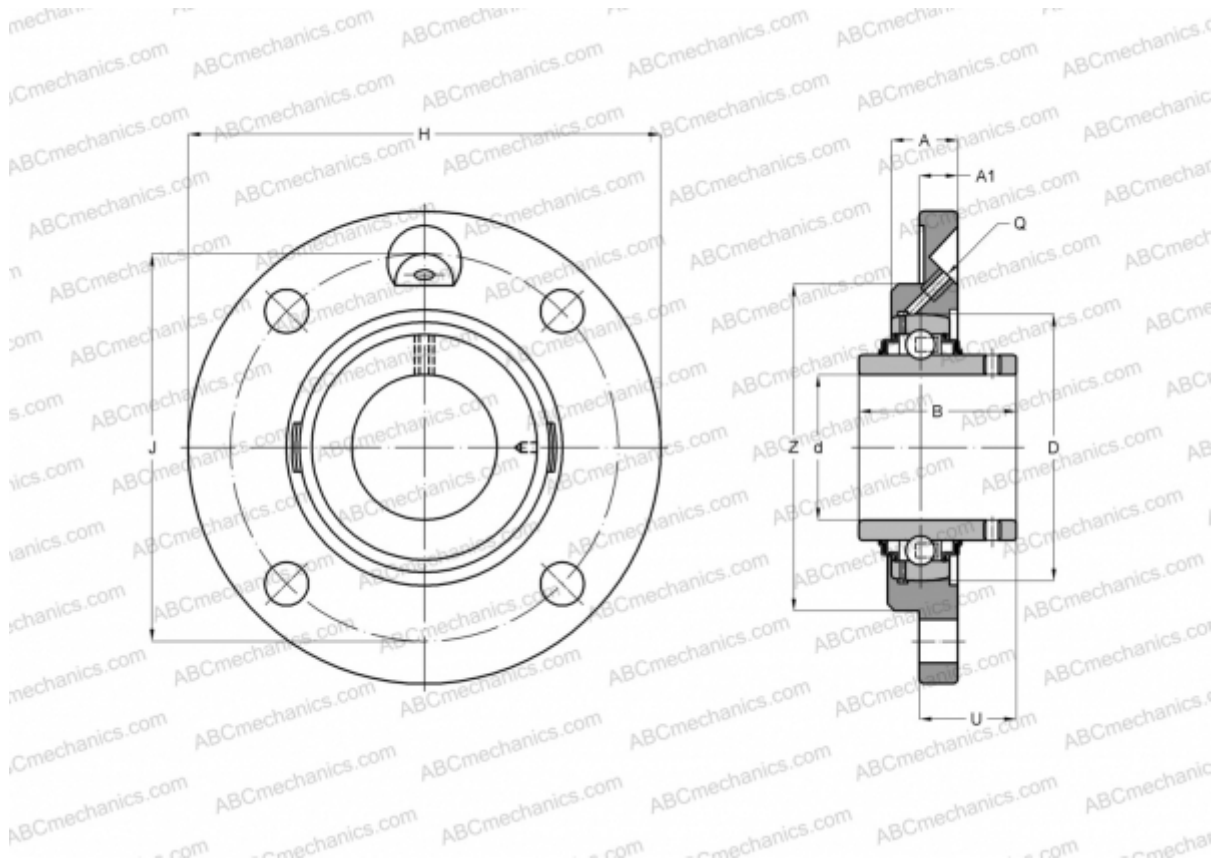

Technical specification

DIMENSIONS, MM

d	65,000
D	120,000
B	68,300
H	205,000
A	50,000
J	170,000
A1	15,000
U	58,900
Z	145,000

WEIGHT, KG

5,700

Bearing	YAR 213-2F
Housing	FYC 513

MANUFACTURER

[SKF](#)

CALCULATION DATA

Basic dynamic load rating, C	55,900 kN
Basic static load rating, Co	40,000 kN
Fatigue load limit, Pu	1,700 kN
Limiting speed	3000 r/min