

CUCFL 208C ASAHI

Ball bearing units

TYPE: Housing units, Two-bolt flanged housing units, Cast iron housing, Radial insert ball bearing with grub screws in inner ring, Type CUCFL..C with cast iron covers, open cover (ASAHI)

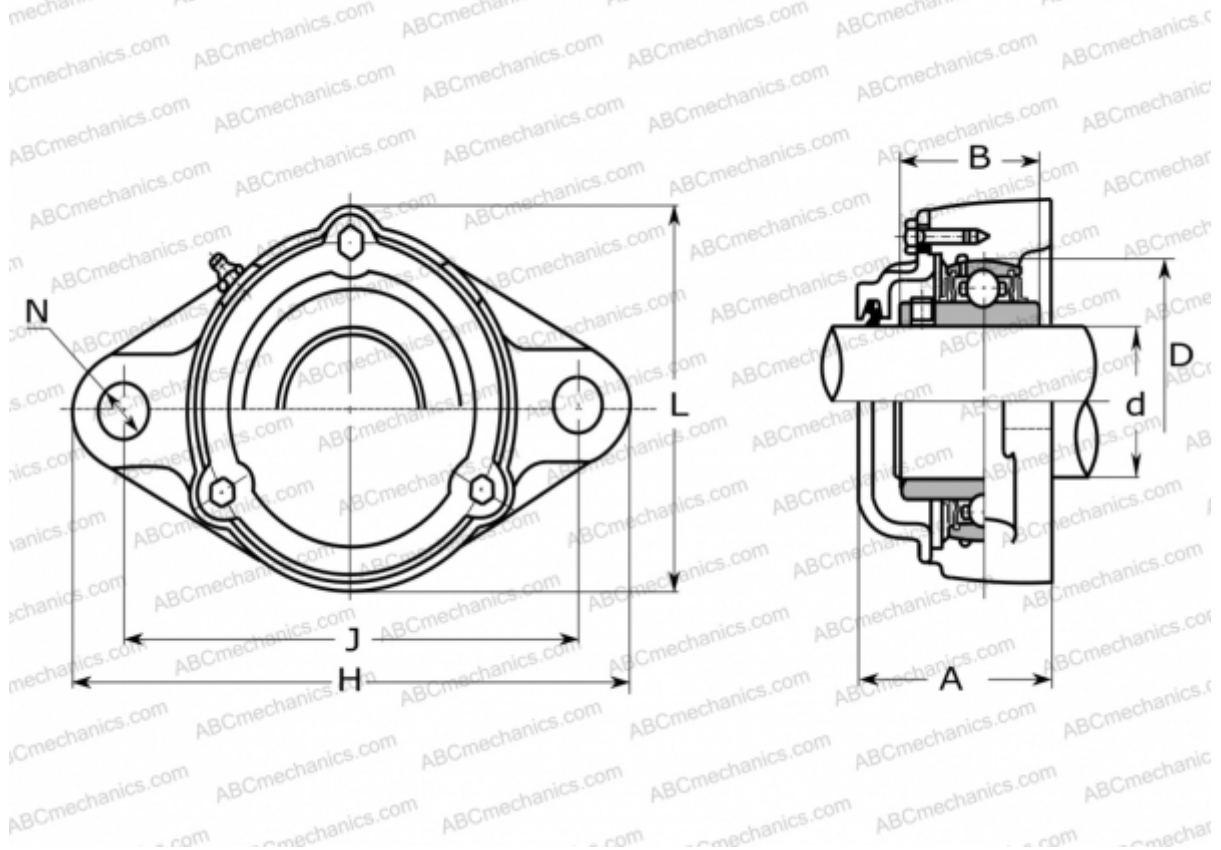

Technical specification

DIMENSIONS, MM

d	40,000
D	80,000
B	49,200
L	104,000
H	175,000
A	66,000
J	144,000
N	16,000

MANUFACTURER

[ASAHI](http://www.asahi.com)

WEIGHT, KG

2,300

Bearing	UC 208
Housing	CFL 208