

CUCFL 204CE ASAHI

Ball bearing units

TYPE: Housing units, Two-bolt flanged housing units, Cast iron housing, Radial insert ball bearing with grub screws in inner ring, Type CUCFL..CE with cast iron covers, closed cover (ASAHI)

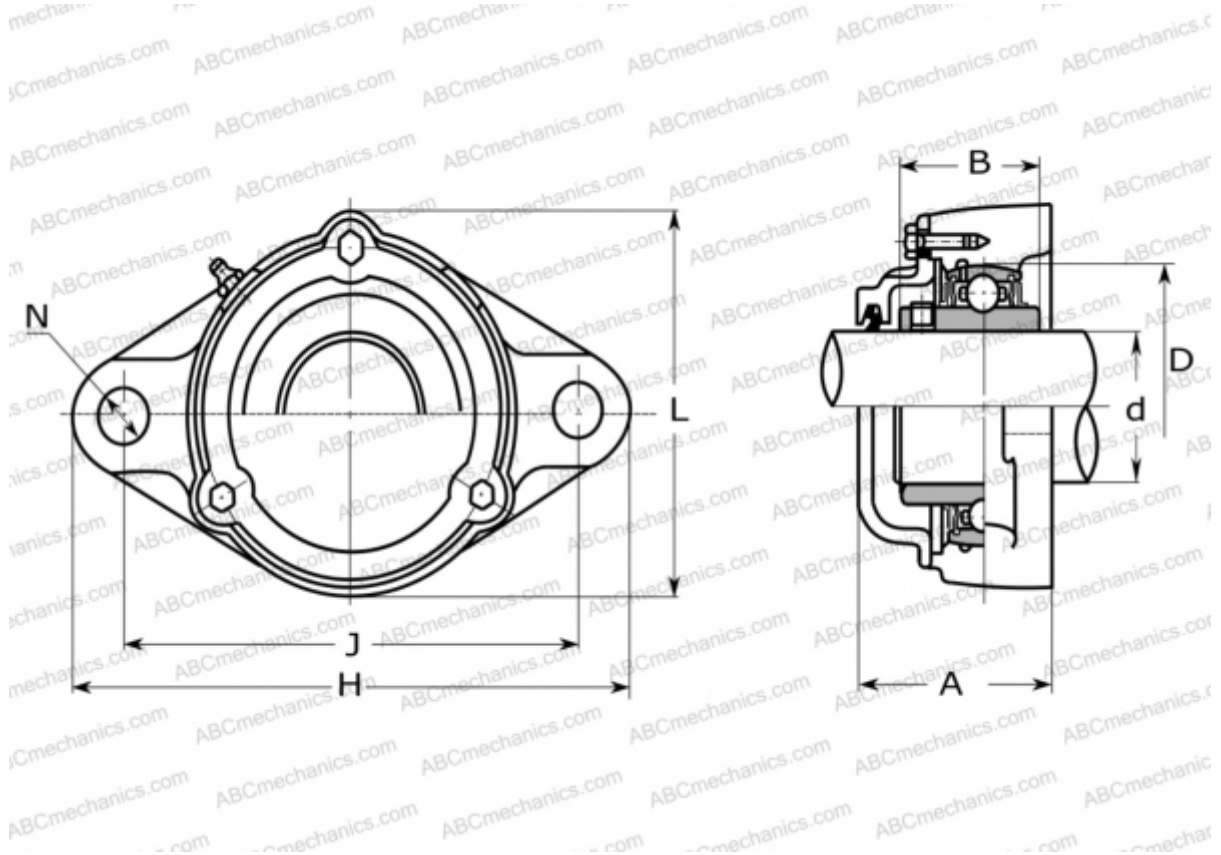

Technical specification

DIMENSIONS, MM

d	20,000
D	47,000
B	31,000
L	66,000
H	113,000
A	46,000
J	90,000
N	12,000

MANUFACTURER

[ASAHI](#)

WEIGHT, KG

0,800

Bearing	UC 204
Housing	CFL 204