

CUCFL 205CE ASAHI

Ball bearing units

TYPE: Housing units, Two-bolt flanged housing units, Cast iron housing, Radial insert ball bearing with grub screws in inner ring, Type CUCFL..CE with cast iron covers, closed cover (ASAHI)

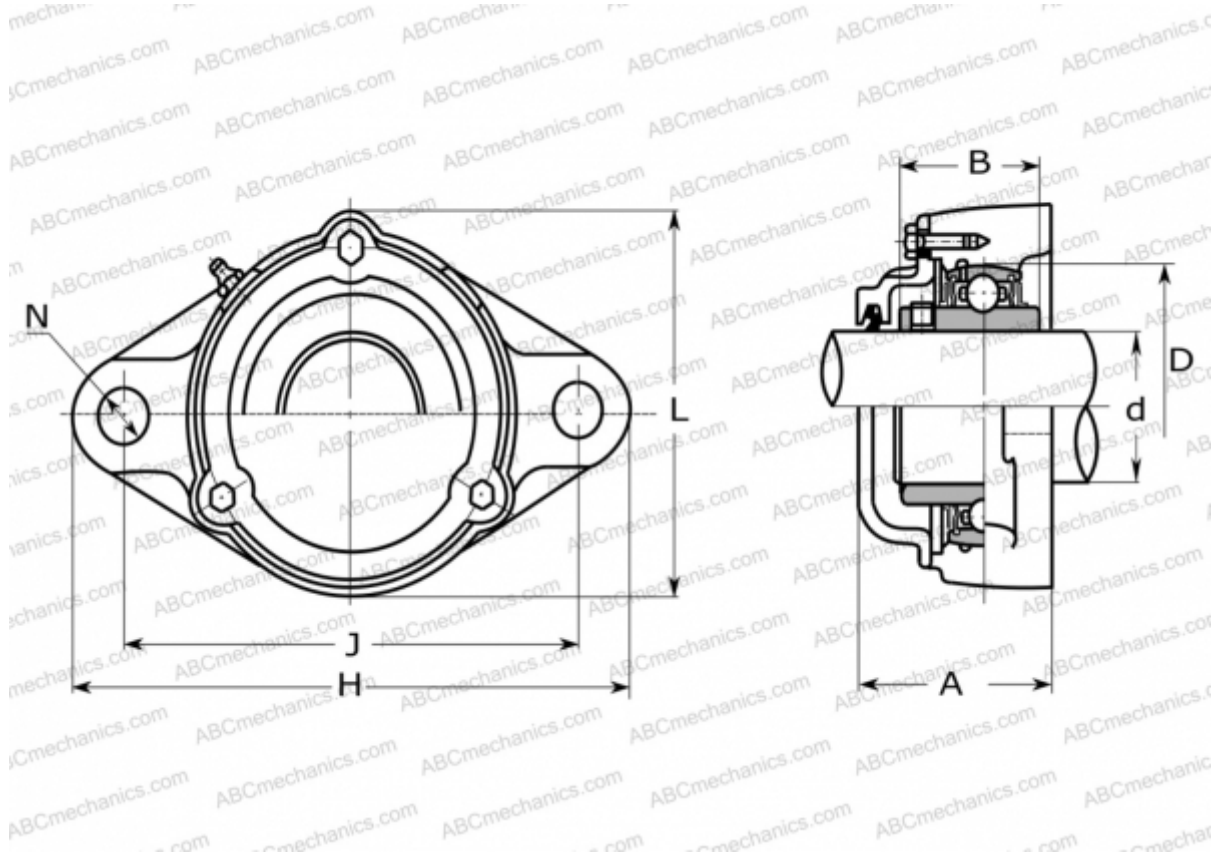

Technical specification

DIMENSIONS, MM

d	25,000
D	52,000
B	34,100
L	73,000
H	130,000
A	51,000
J	99,000
N	16,000

MANUFACTURER

[ASAHI](#)

WEIGHT, KG

1,000

Bearing	UC 205
Housing	CFL 205