

## CUCFL 207CE ASAHI

Ball bearing units

TYPE: Housing units, Two-bolt flanged housing units, Cast iron housing, Radial insert ball bearing with grub screws in inner ring, Type CUCFL..CE with cast iron covers, closed cover (ASAHI)

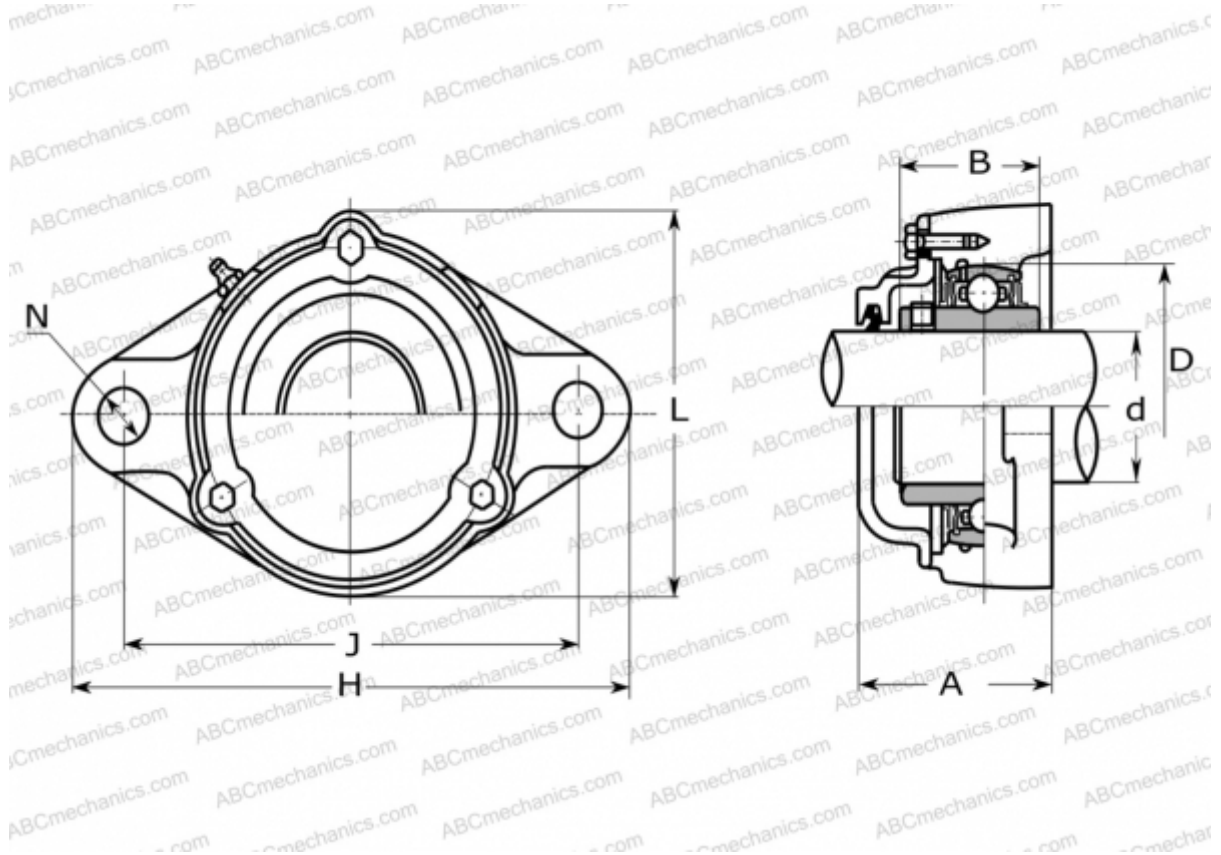

### Technical specification

#### DIMENSIONS, MM

d	35,000
D	72,000
B	42,900
L	94,000
H	161,000
A	59,000
J	130,000
N	16,000

#### MANUFACTURER

[ASAHI](http://www.asahi.com)

#### WEIGHT, KG

1,900

Bearing	UC 207
Housing	CFL 207