

## CUCFL 210CE ASAHI

Ball bearing units

TYPE: Housing units, Two-bolt flanged housing units, Cast iron housing, Radial insert ball bearing with grub screws in inner ring, Type CUCFL..CE with cast iron covers, closed cover (ASAHI)

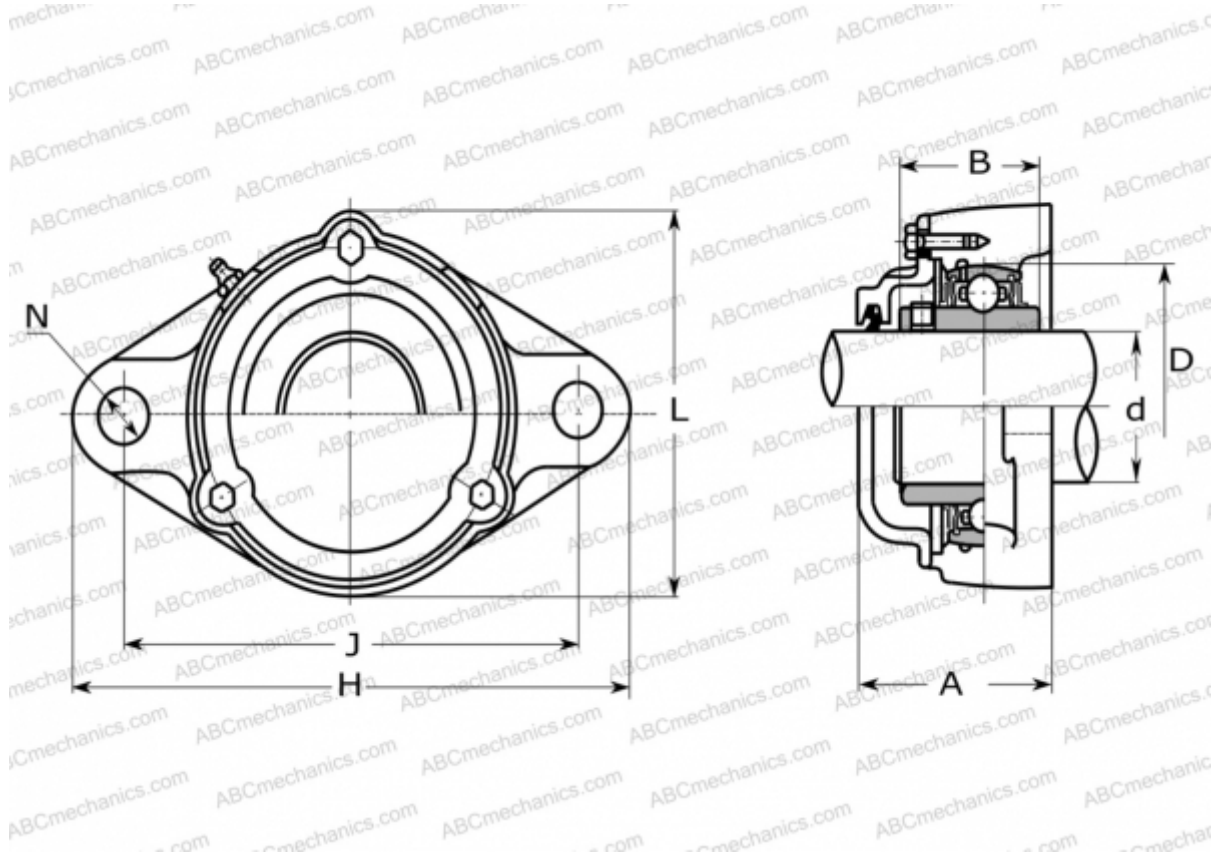

### Technical specification

#### DIMENSIONS, MM

d	50,000
D	90,000
B	51,600
L	120,000
H	197,000
A	71,000
J	157,000
N	19,000

#### MANUFACTURER

[ASAHI](#)

#### WEIGHT, KG

3,200

Bearing	UC 210
Housing	CFL 210