

CUCFL 211CE ASAHI

Ball bearing units

TYPE: Housing units, Two-bolt flanged housing units, Cast iron housing, Radial insert ball bearing with grub screws in inner ring, Type CUCFL..CE with cast iron covers, closed cover (ASAHI)

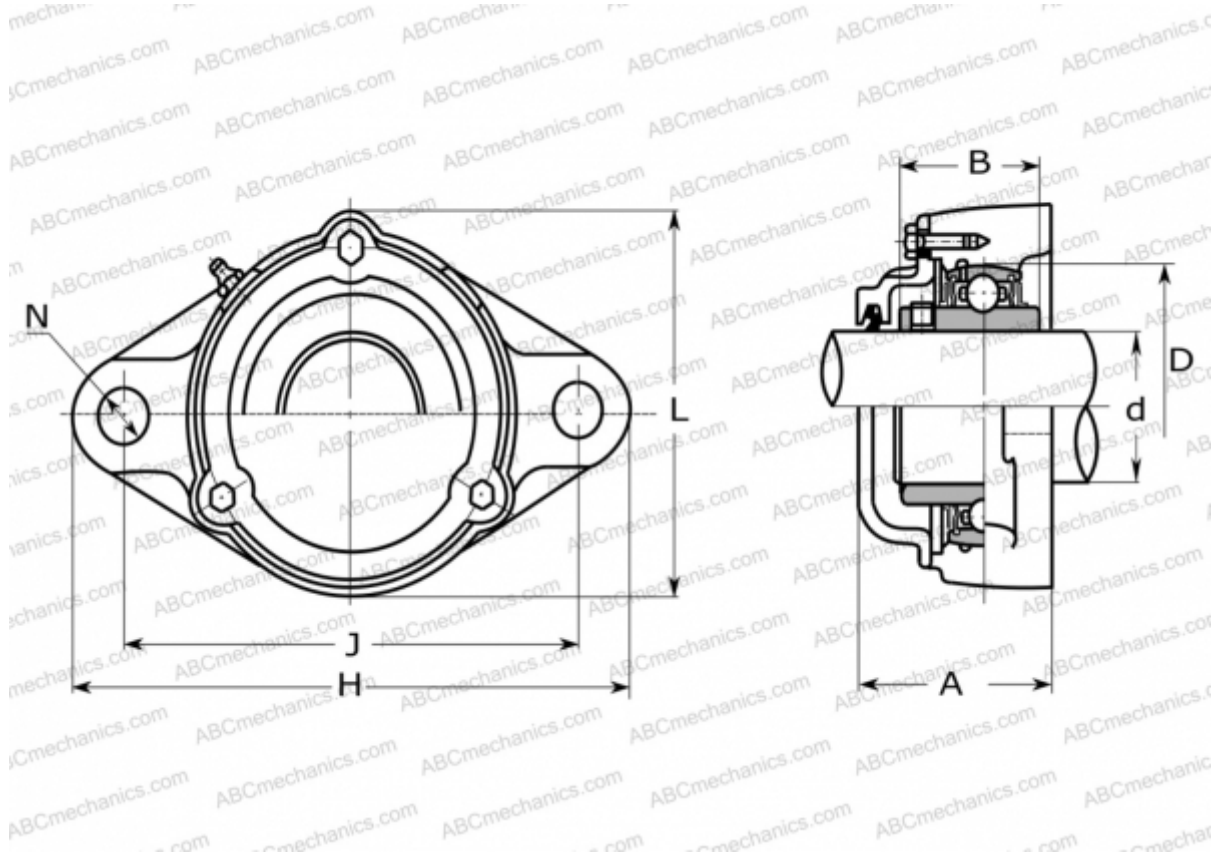

Technical specification

DIMENSIONS, MM

d	55,000
D	100,000
B	55,600
L	134,000
H	224,000
A	75,000
J	184,000
N	19,000

MANUFACTURER

[ASAHI](http://www.asahi.com)

WEIGHT, KG

4,300

Bearing	UC 211
Housing	CFL 211