

CUCFL 212CE ASAHI

Ball bearing units

TYPE: Housing units, Two-bolt flanged housing units, Cast iron housing, Radial insert ball bearing with grub screws in inner ring, Type CUCFL..CE with cast iron covers, closed cover (ASAHI)

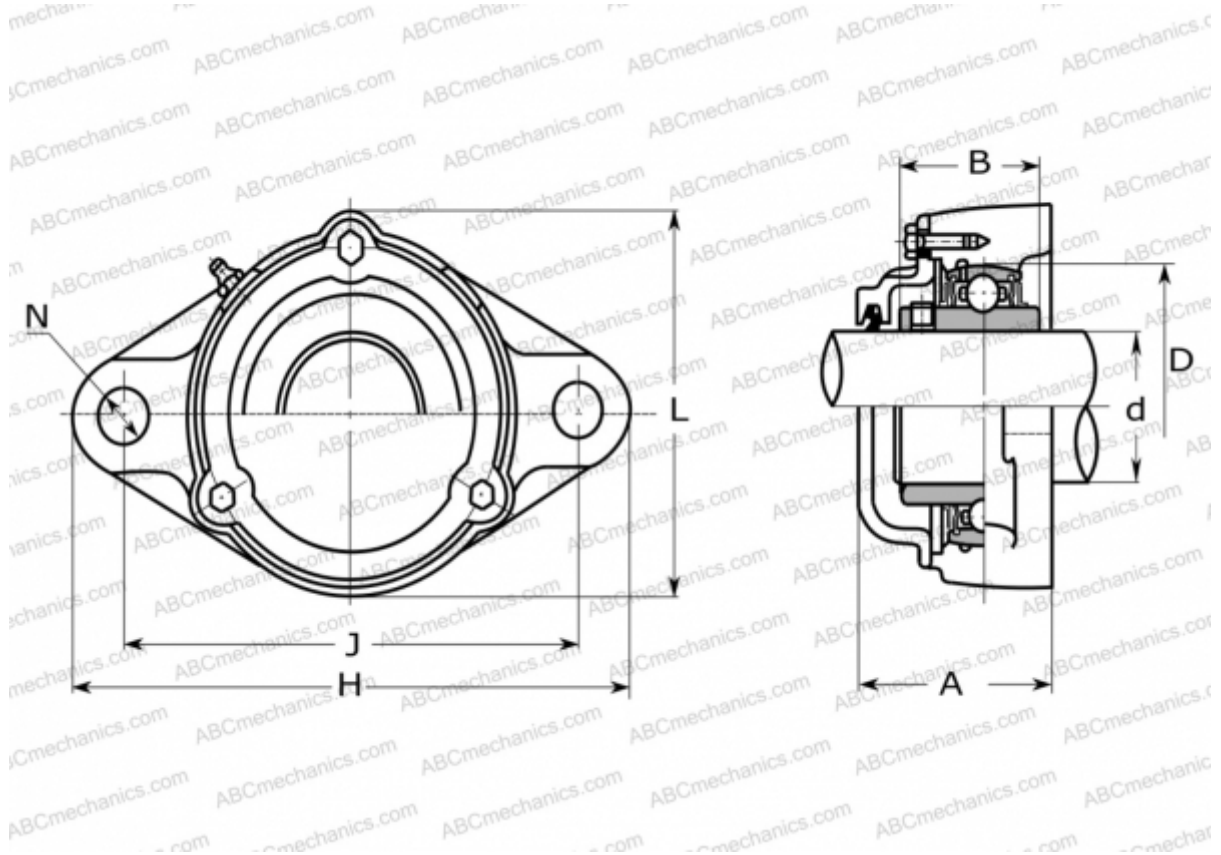

Technical specification

DIMENSIONS, MM

d	60,000
D	110,000
B	65,100
L	144,000
H	250,000
A	86,000
J	202,000
N	23,000

MANUFACTURER

[ASAHI](#)

WEIGHT, KG

5,400

Bearing	UC 212
Housing	CFL 212