

CUCFL 214CE ASAHI

Ball bearing units

TYPE: Housing units, Two-bolt flanged housing units, Cast iron housing, Radial insert ball bearing with grub screws in inner ring, Type CUCFL..CE with cast iron covers, closed cover (ASAHI)

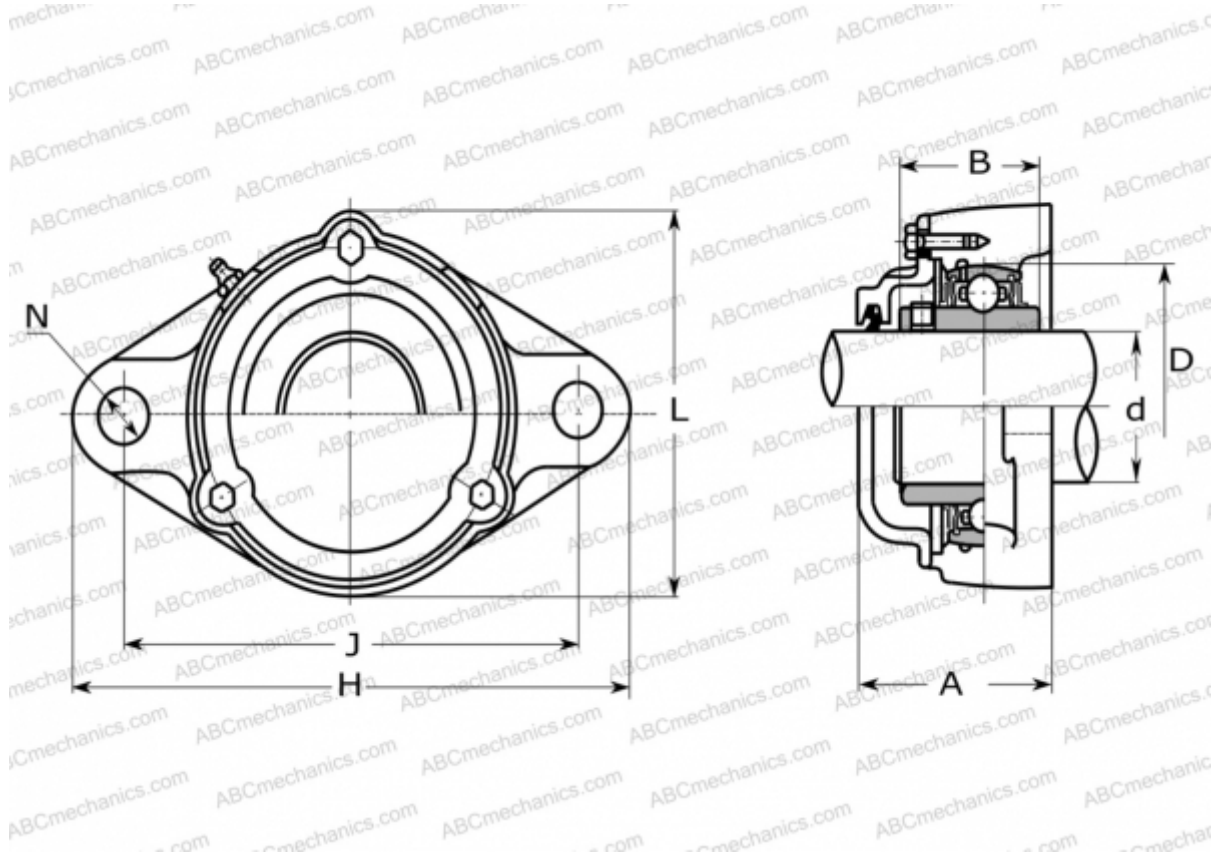

Technical specification

DIMENSIONS, MM

d	70,000
D	125,000
B	74,600
L	163,000
H	265,000
A	98,000
J	216,000
N	23,000

MANUFACTURER

[ASAHI](#)

WEIGHT, KG

7,400

Bearing	UC 214
Housing	CFL 214