

CUCFL 218CE ASAHI

Ball bearing units

TYPE: Housing units, Two-bolt flanged housing units, Cast iron housing, Radial insert ball bearing with grub screws in inner ring, Type CUCFL..CE with cast iron covers, closed cover (ASAHI)

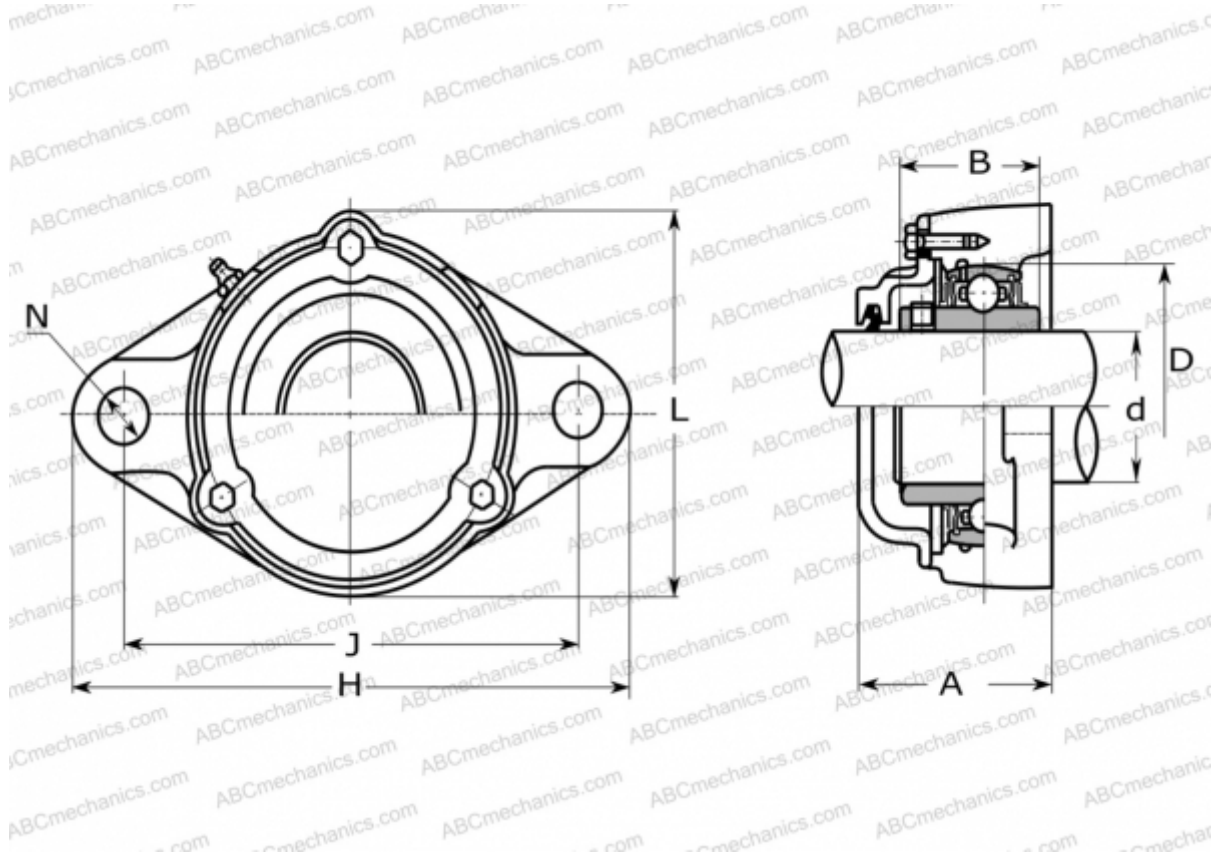

Technical specification

DIMENSIONS, MM

d	90,000
D	160,000
B	96,000
L	211,000
H	320,000
A	122,000
J	265,000
N	25,000

MANUFACTURER

[ASAHI](http://www.asahi.com)

WEIGHT, KG

15,000

Bearing	UC 218
Housing	CFL 218