

## UCFL 203C ASAHI

Ball bearing units

TYPE: Housing units, Two-bolt flanged housing units, Cast iron housing, Radial insert ball bearing with grub screws in inner ring, Type UCFL..C with pressed steel covers, open cover (ASAHI)

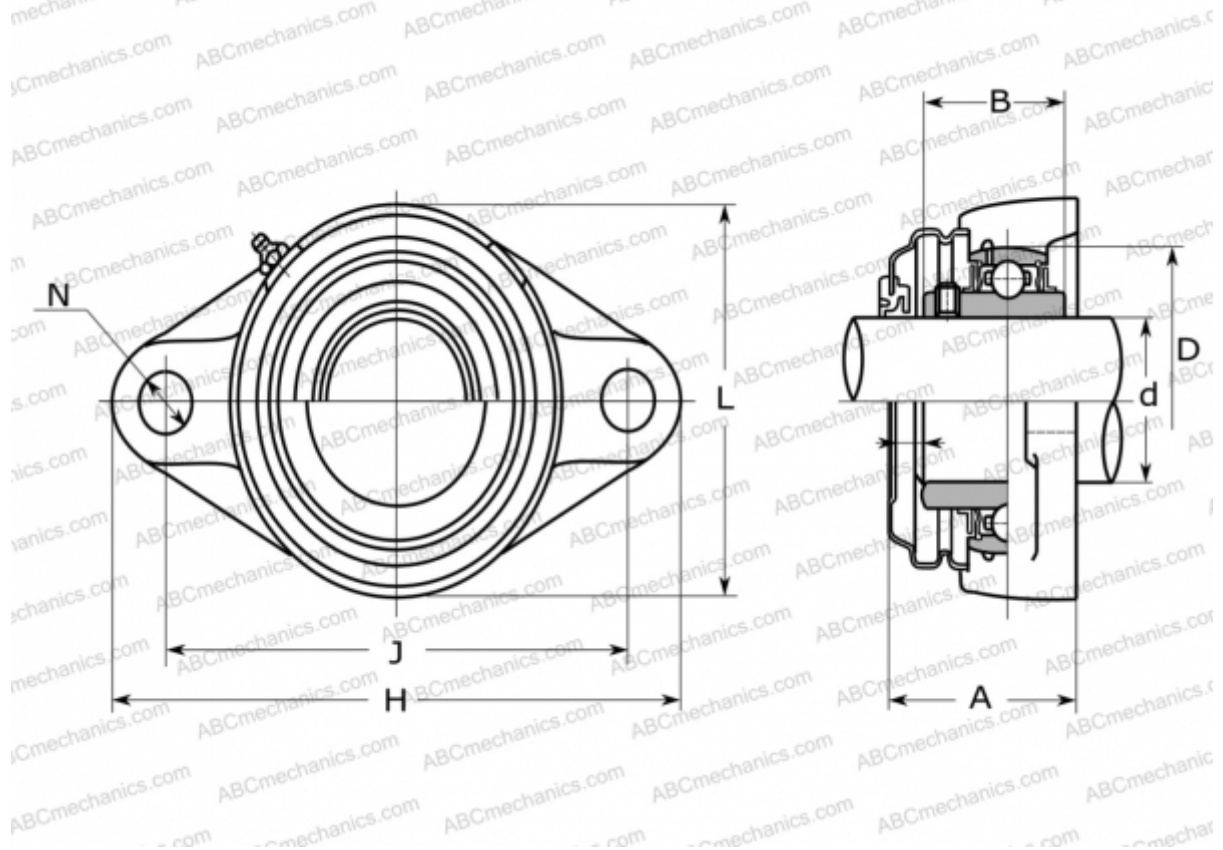

### Technical specification

#### DIMENSIONS, MM

d	17,000
D	47,000
B	31,000
L	60,000
H	113,000
A	43,000
J	90,000
N	12,000

#### MANUFACTURER

[ASAHI](http://www.asahi.com)

#### WEIGHT, KG

0,500

Bearing	UC 203
Housing	FL 204C