

UCFL 205C ASAHI

Ball bearing units

TYPE: Housing units, Two-bolt flanged housing units, Cast iron housing, Radial insert ball bearing with grub screws in inner ring, Type UCFL..C with pressed steel covers, open cover (ASAHI)

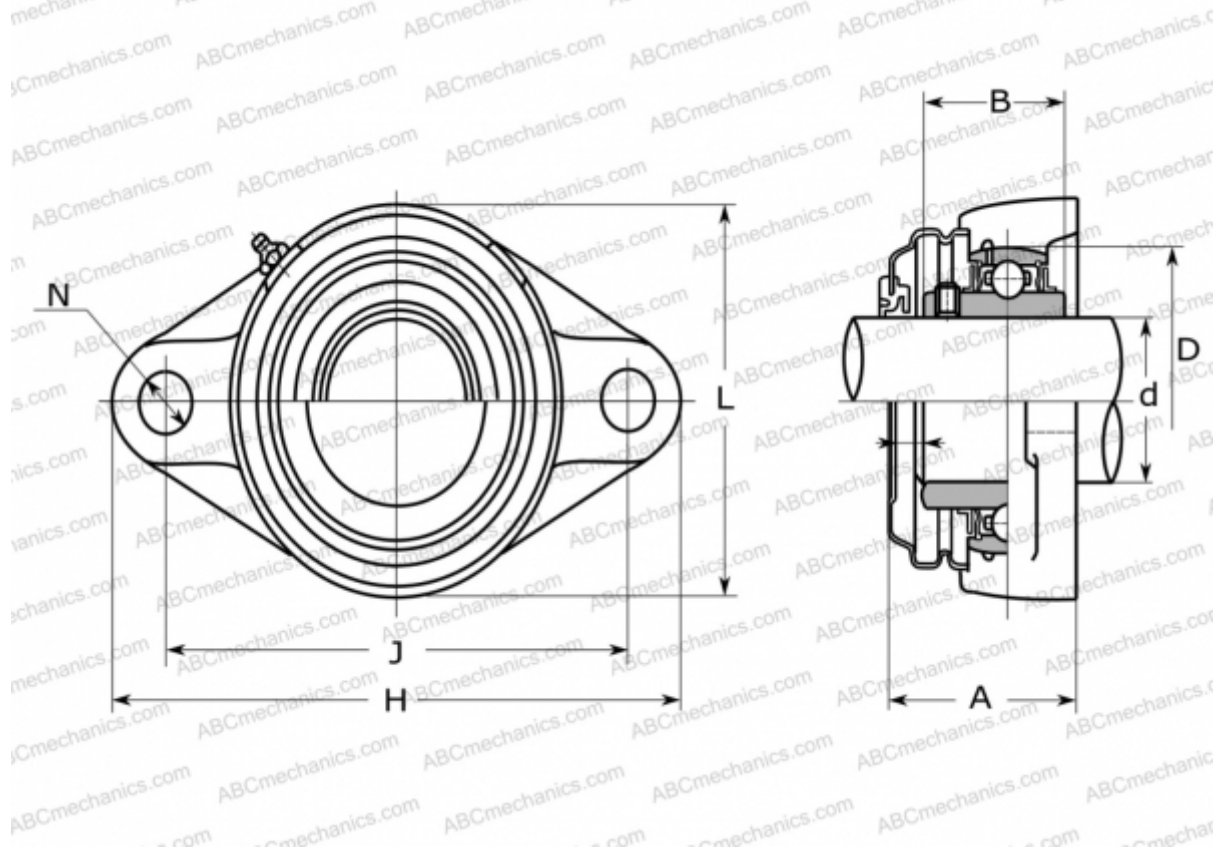

Technical specification

DIMENSIONS, MM

d	25,000
D	52,000
B	34,100
L	68,000
H	130,000
A	47,000
J	99,000
N	16,000

MANUFACTURER

[ASAHI](#)

WEIGHT, KG

0,670

Bearing	UC 205
Housing	FL 205C