

UCFL 207C ASAHI

Ball bearing units

TYPE: Housing units, Two-bolt flanged housing units, Cast iron housing, Radial insert ball bearing with grub screws in inner ring, Type UCFL..C with pressed steel covers, open cover (ASAHI)

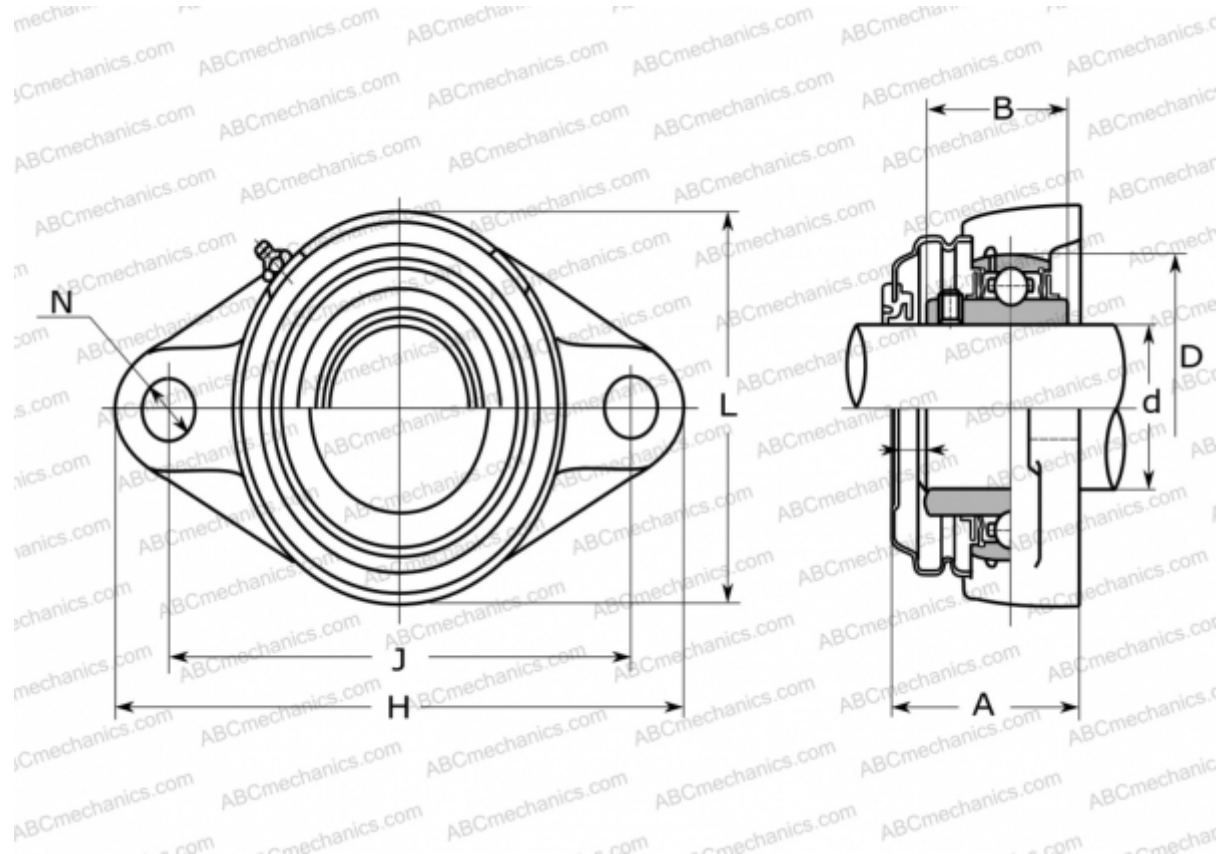

Technical specification

DIMENSIONS, MM

d	35,000
D	72,000
B	42,900
L	90,000
H	161,000
A	54,000
J	130,000
N	16,000

MANUFACTURER

[ASAHI](http://www.asahi.com)

WEIGHT, KG

1,300

Bearing	UC 207
Housing	FL 207C