

## UCFL 210C ASAHI

Ball bearing units

TYPE: Housing units, Two-bolt flanged housing units, Cast iron housing, Radial insert ball bearing with grub screws in inner ring, Type UCFL..C with pressed steel covers, open cover (ASAHI)

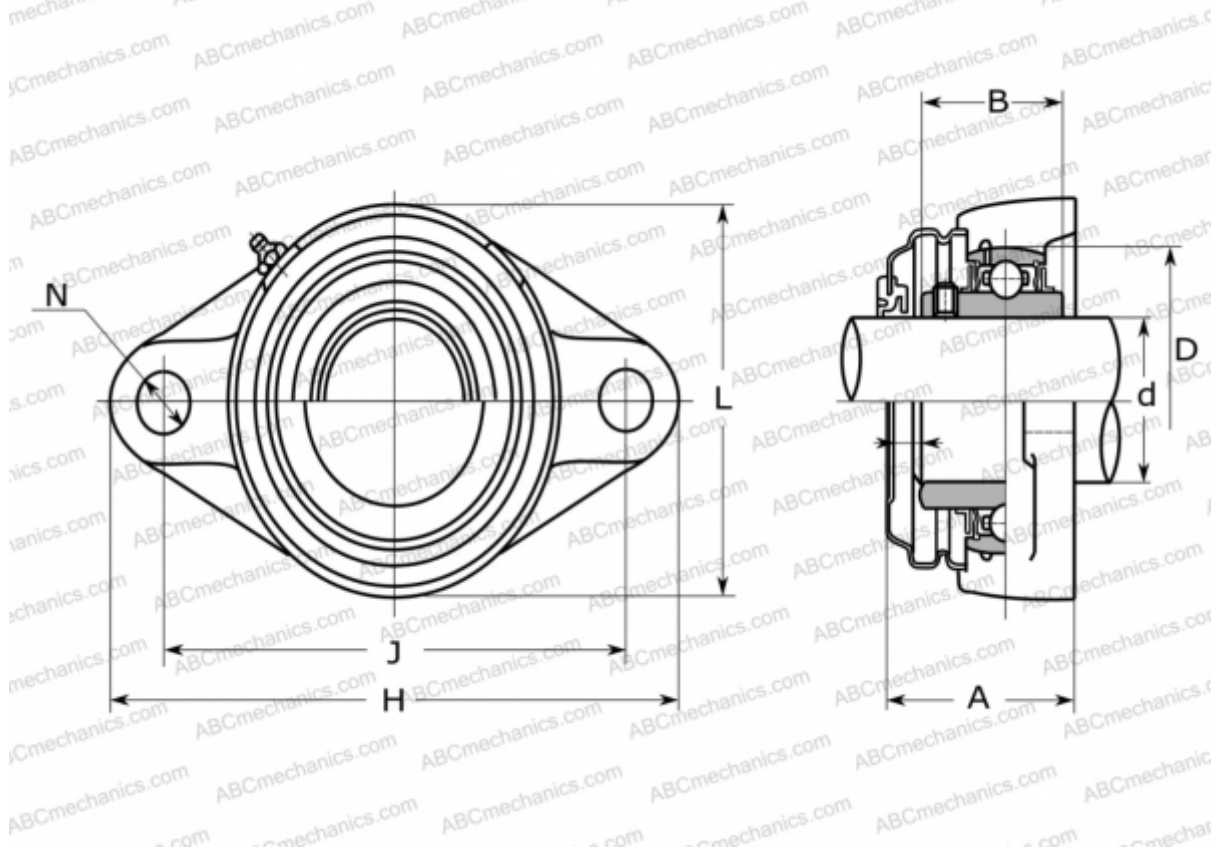

### Technical specification

#### DIMENSIONS, MM

d	50,000
D	90,000
B	51,600
L	115,000
H	197,000
A	66,000
J	157,000
N	19,000

#### MANUFACTURER

[ASAHI](#)

#### WEIGHT, KG

2,300

Bearing	UC 210
Housing	FL 210C