

UCFL 213C ASAHI

Ball bearing units

TYPE: Housing units, Two-bolt flanged housing units, Cast iron housing, Radial insert ball bearing with grub screws in inner ring, Type UCFL..C with pressed steel covers, open cover (ASAHI)

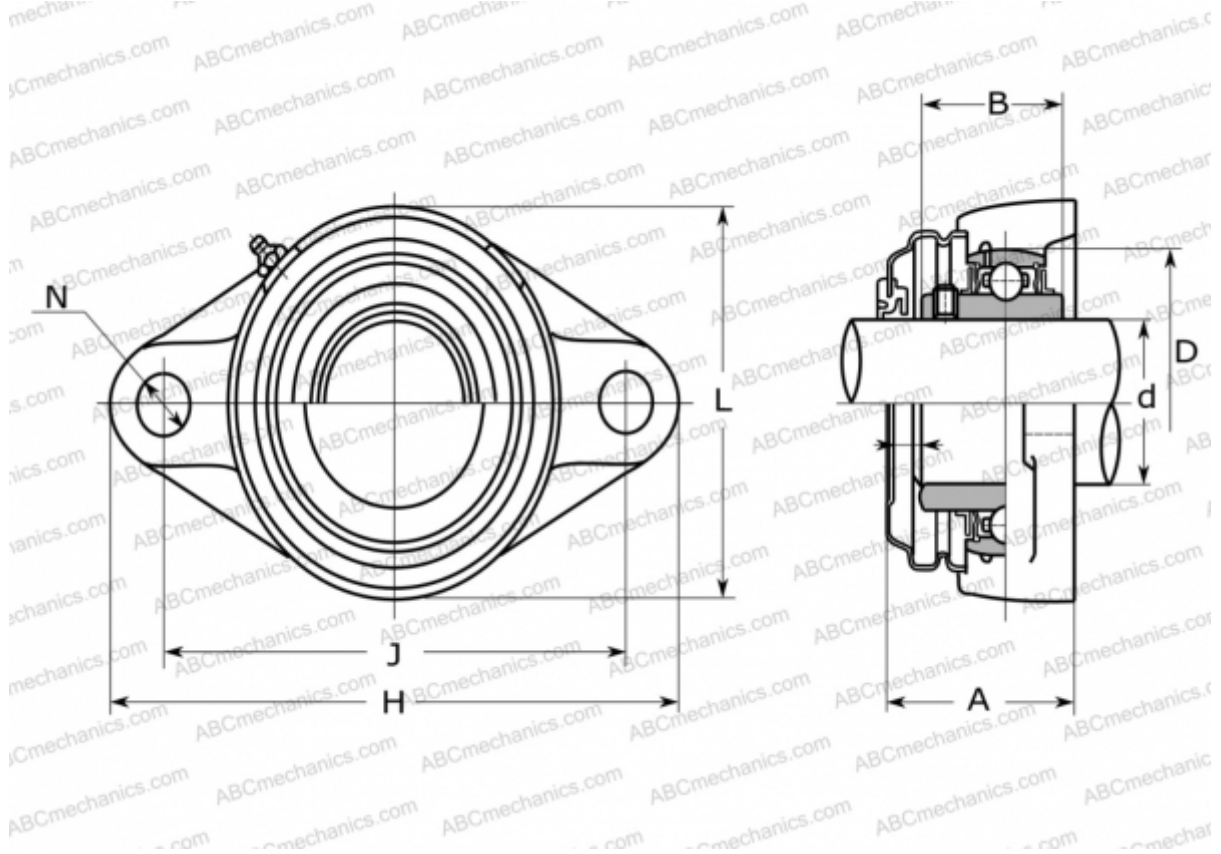

Technical specification

DIMENSIONS, MM

d	65,000
D	120,000
B	65,100
L	155,000
H	258,000
A	81,000
J	210,000
N	23,000

MANUFACTURER

[ASAHI](#)

WEIGHT, KG

5,300

Bearing	UC 213
Housing	FL 213C