

UCFL 202E ASAHI

Ball bearing units

TYPE: Housing units, Two-bolt flanged housing units, Cast iron housing, Radial insert ball bearing with grub screws in inner ring, Type UCFL..E with pressed steel covers, closed cover (ASAHI)

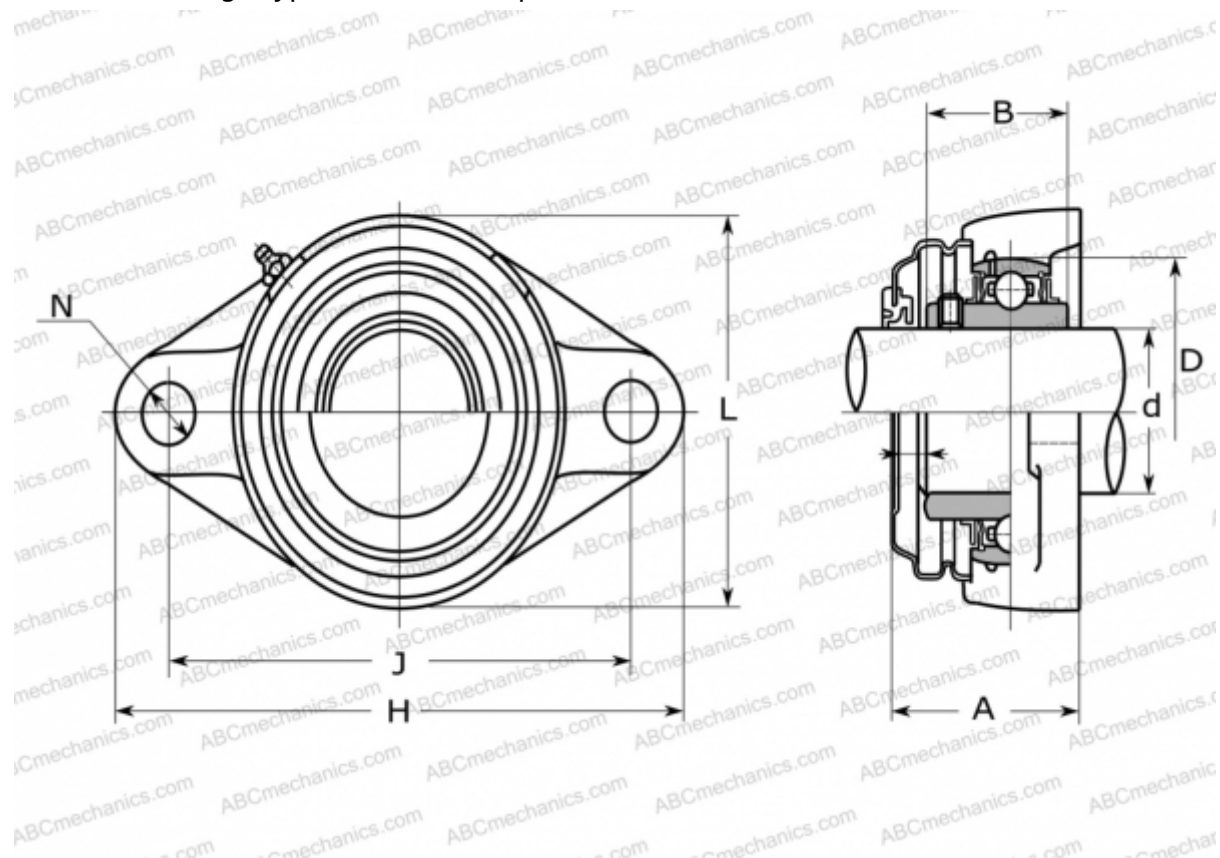

Technical specification

DIMENSIONS, MM

d	15,000
D	47,000
B	31,000
L	60,000
H	113,000
A	43,000
J	90,000
N	12,000

MANUFACTURER

[ASAHI](http://www.asahi.com)

WEIGHT, KG

0,510

Bearing	UC 202
Housing	FL 204C