

## UCFL 205E ASAHI

Ball bearing units

TYPE: Housing units, Two-bolt flanged housing units, Cast iron housing, Radial insert ball bearing with grub screws in inner ring, Type UCFL..E with pressed steel covers, closed cover (ASAHI)

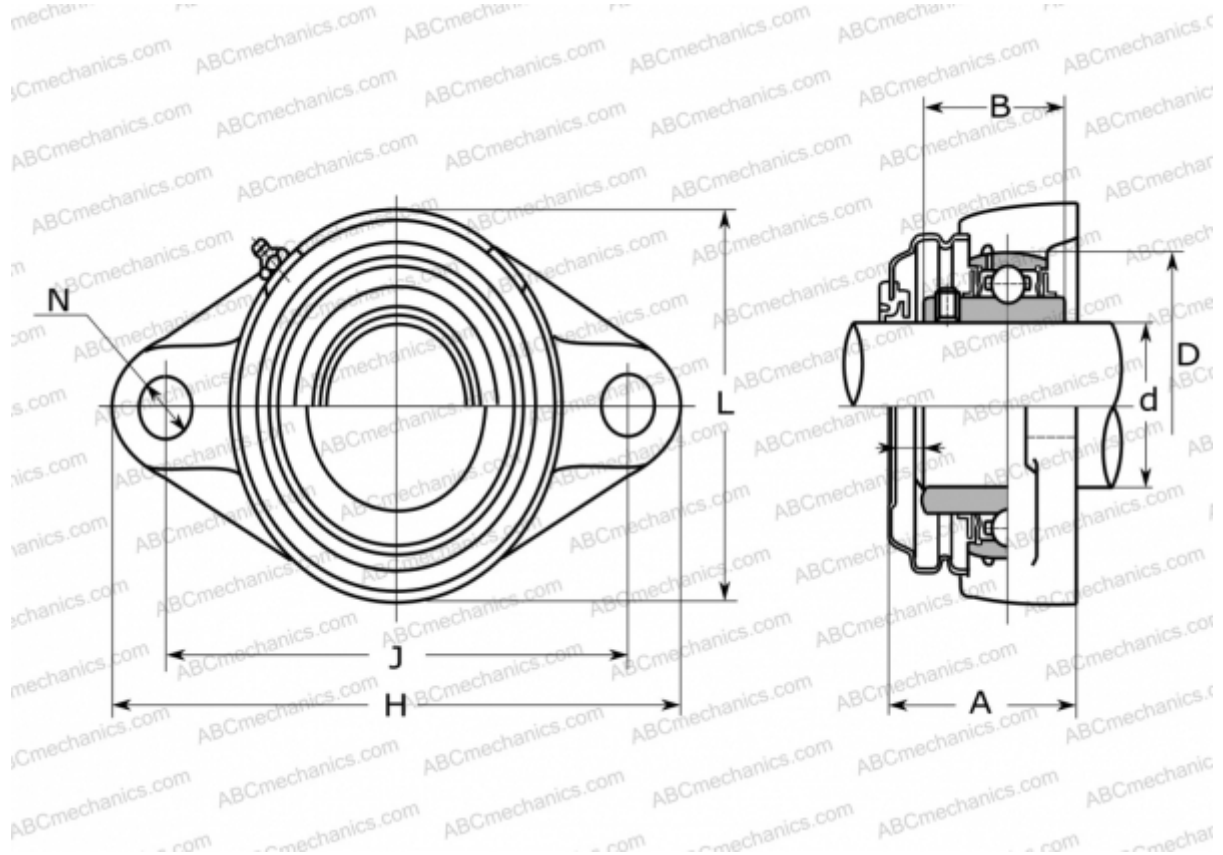

### Technical specification

#### DIMENSIONS, MM

d	25,000
D	52,000
B	34,100
L	68,000
H	130,000
A	47,000
J	99,000
N	16,000

#### MANUFACTURER

[ASAHI](http://www.asahi.com)

#### WEIGHT, KG

0,670

Bearing	UC 205
Housing	FL 205C