

## UCFL 209E ASAHI

Ball bearing units

TYPE: Housing units, Two-bolt flanged housing units, Cast iron housing, Radial insert ball bearing with grub screws in inner ring, Type UCFL..E with pressed steel covers, closed cover (ASAHI)

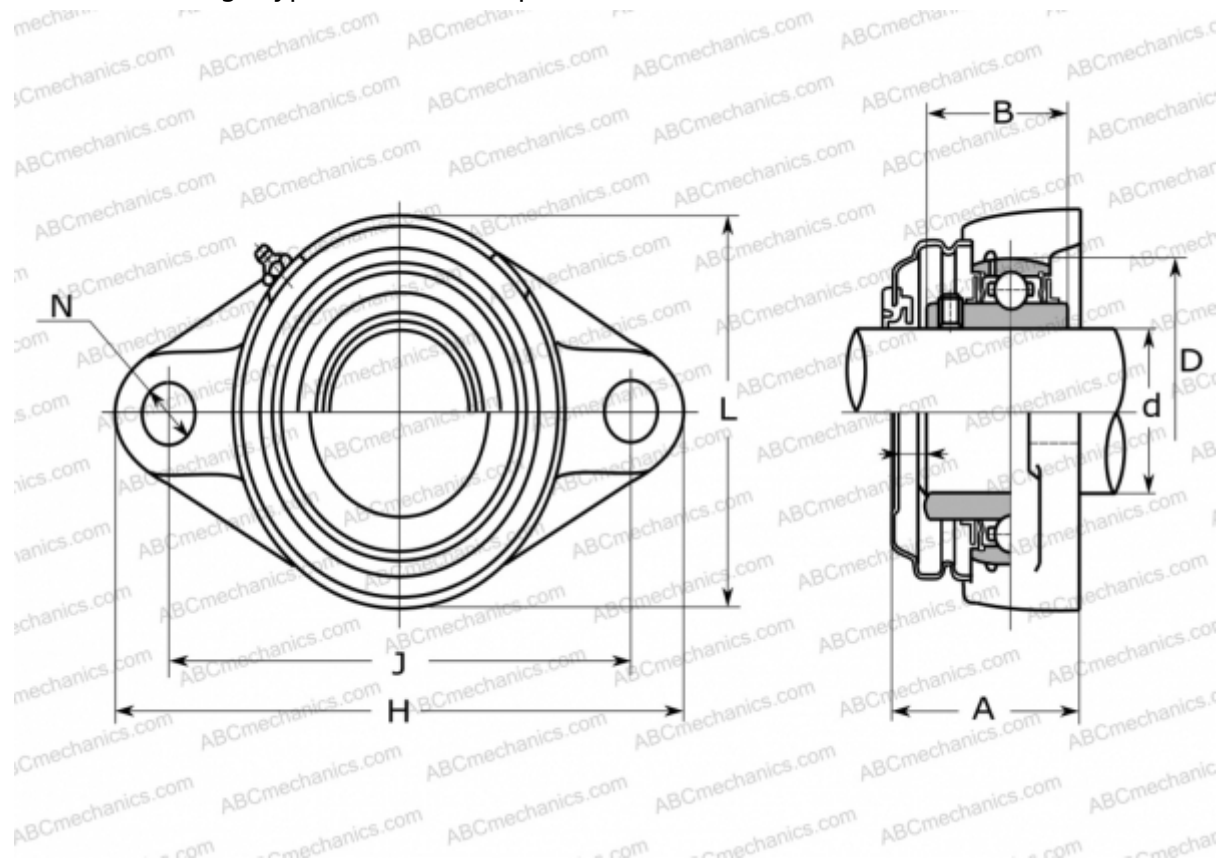

### Technical specification

#### DIMENSIONS, MM

d	45,000
D	85,000
B	49,200
L	108,000
H	188,000
A	63,000
J	148,000
N	19,000

#### MANUFACTURER

[ASAHI](http://www.asahi.com)

#### WEIGHT, KG

2,000

Bearing	UC 209
Housing	FL 209C