

## UCFL 211E ASAHI

Ball bearing units

TYPE: Housing units, Two-bolt flanged housing units, Cast iron housing, Radial insert ball bearing with grub screws in inner ring, Type UCFL..E with pressed steel covers, closed cover (ASAHI)

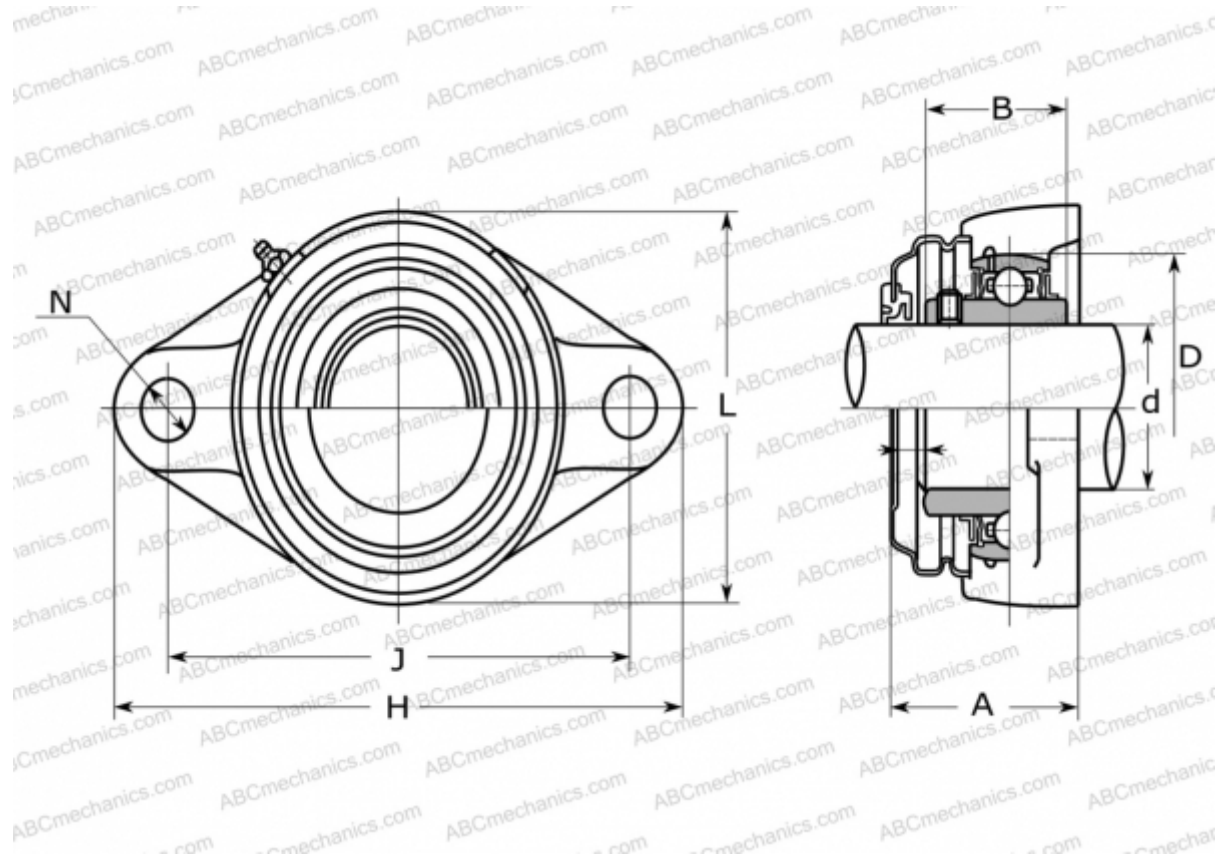

### Technical specification

#### DIMENSIONS, MM

d	55,000
D	100,000
B	55,600
L	130,000
H	224,000
A	69,000
J	184,000
N	19,000

#### MANUFACTURER

[ASAHI](http://www.asahi.com)

#### WEIGHT, KG

3,300

Bearing	UC 211
Housing	FL 211C