

UCFK 202 ASAHI

Ball bearing units

TYPE: Housing units, Three-bolt flange bracket units, Cast iron housing, Radial insert ball bearing with grub screws in inner ring, Type UCFK (ASAHI)

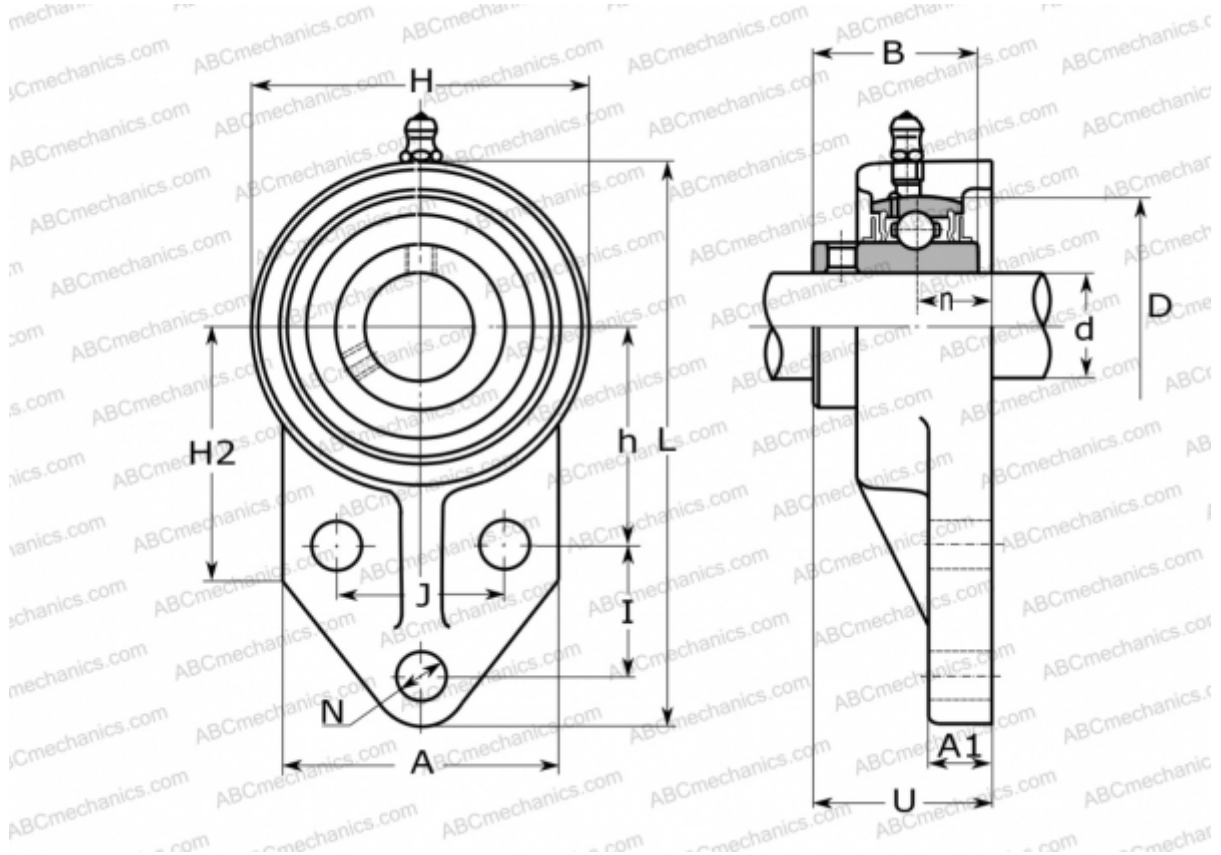

Technical specification

DIMENSIONS, MM

d	15,000
D	47,000
B	31,000
L	110,000
H	62,000
A	52,000
H2	52,000
J	32,000
A1	13,000
N	10,000
U	33,300
I	27,000
h	42,000
n	15,000

WEIGHT, KG

	0,580
Bearing	UC 202
Housing	FK 204

MANUFACTURER

[ASAHI](#)